

ELASTRON products catalogue

Steel sheet Symdeck

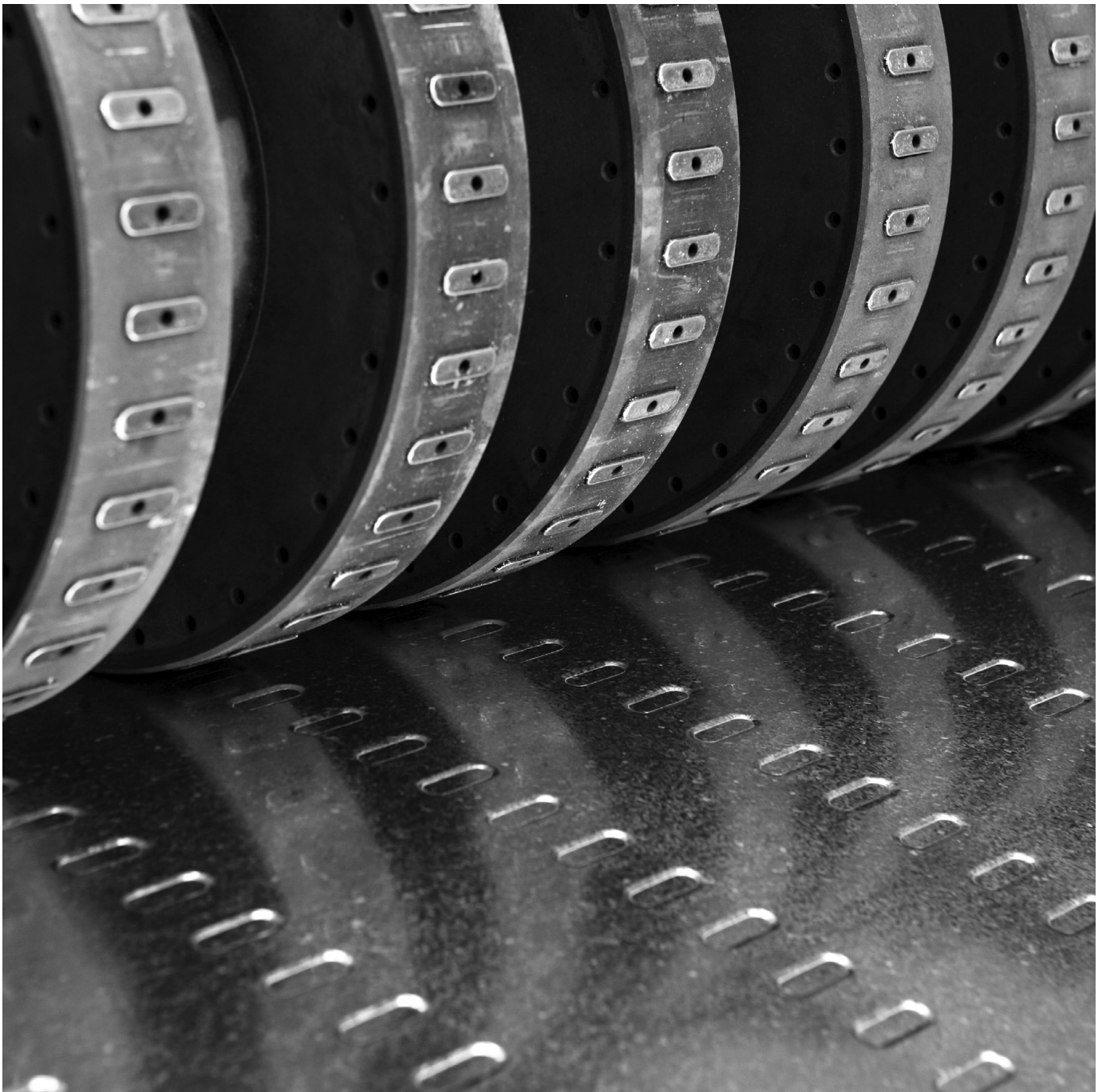



Contents

General information about composite decks.....	5
Steel sheet Symdeck	6
Design of composite slabs	8
Design tables Symdeck 50.....	10
Design tables Symdeck 73.....	15
Design tables Symdeck 100.....	21
Fire dimensional sizing boards Symdeck 50.....	26
Fire dimensional sizing boards Symdeck 73.....	39
Fire dimensional sizing boards Symdeck 100.....	52
Lightweight steel panel design panels Symdeck 73	65
Composite floor decks construction details	69



Steel sheet Symdeck



General information about composite decks

Composite slabs are called the load-bearing roof slabs of buildings, which consist of profiled steel sheeting and reinforced concrete.

The composite method of deck construction was first introduced in North America and is increasingly being used in Europe and in Greece. In particular, the use of composite slabs has contributed to the increase in the use of metal structures in construction projects.

During the last years the use of composite decks in civil engineering structures has been increased due to the advantages that it offers with respect to more traditional solutions. The benefits from the usage of composite decks is summarized below:

- Less construction time is required.
- The usage of wooden formwork is avoided.
- They can be used to bridge larger spans with a corresponding reduction in metal wire.

The main component of the composite decks is the profiled steel sheeting which during the construction phase, functions as formwork supporting the wet concrete (Figure 1).

After the hardening of the concrete, the composite decks undertake the additional imposed loads.

Usually, a light reinforcement is applied to the upper surface of the composite deck (Figure 2) which protects the concrete from cracking in the case that a continuous beam structural system is adopted; this reinforcement also gives to the composite deck the ability to undertake the negative bending of the supports.

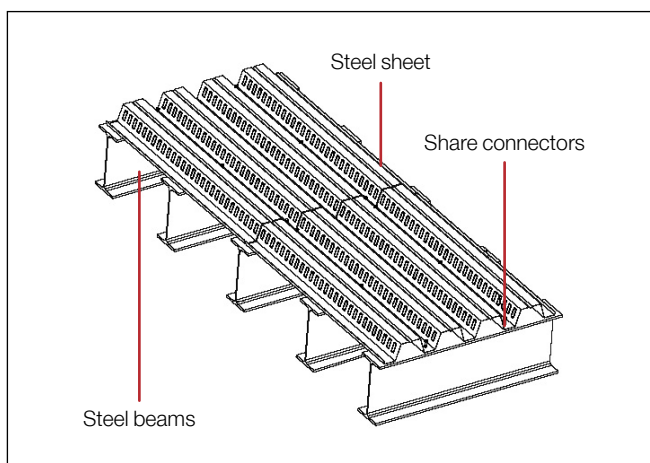

Figure 1: Typical composite slab infrastructure layout.

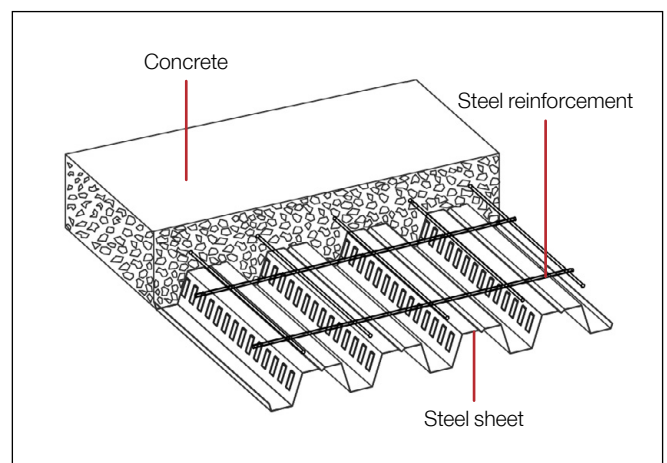

Figure 2: Configuration of the composite slab.

Steel sheet Symdeck

The SYMDECK Metal Sheet is a galvanized trapezoidal profile used for the construction of composite slabs with large openings. It can also be used as a purely metal carrier for covering large openings.

The upper foot of the steel sheet is reinforced against local bending with an intermediate reinforcement in the middle. There are special ribs (impressions) in the trunk, which give the extra connection required between steel sheet and concrete in order to transfer the forces through shear length that develop between the two materials.

The steel sheets are always produced with the high levels of factory quality in thickness from 0,75 to 1,25mm. The steel used is of high quality S320GD according to the EUROCODE 3, galvanized, with a choice of paint in a wide range of colors. The geometric and inertial characteristics of the profile for each thickness are shown in the following figures and tables.

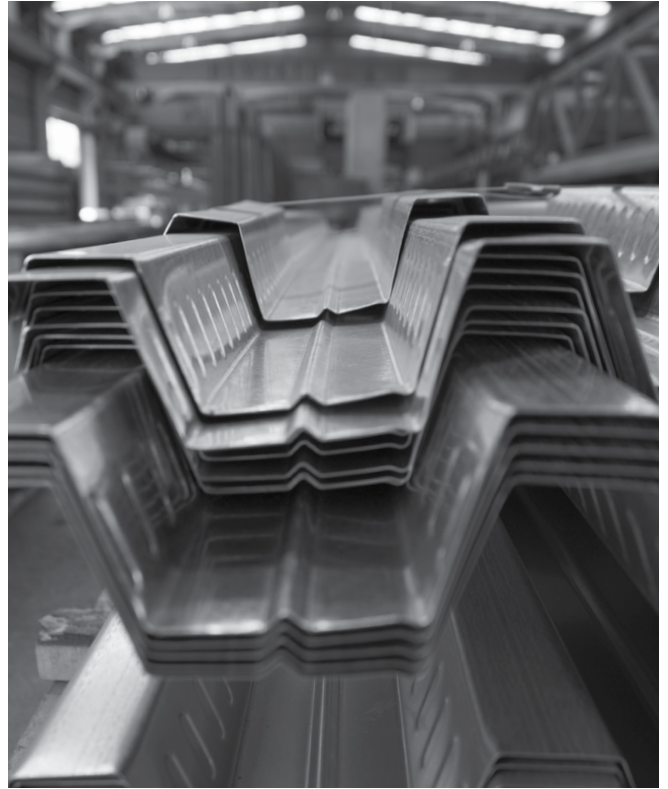

Characteristics of Metal Sheet Symdeck 50

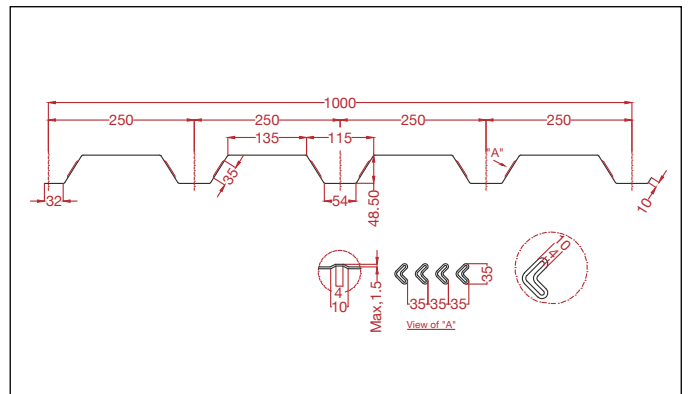
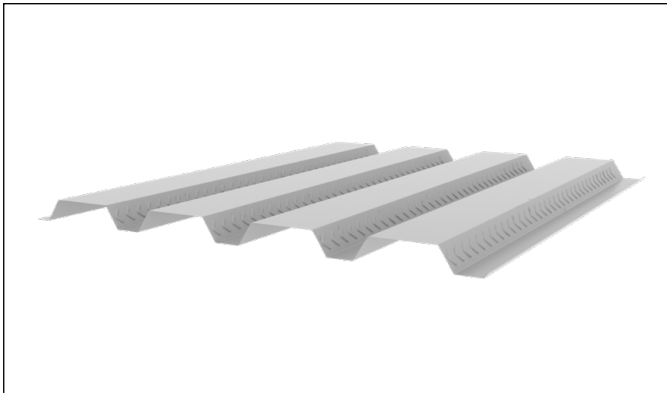

Opening: 1250 mm **Thickness:** 0,75 mm - 1,25 mm **Cover:** 1000 ± 5 mm **Depth:** 48,5 ± 1 mm **Step:** 250 ± 2 mm

Thickness	t (mm)	0,75	1,00	1,25
Weight	G (kg/m)	7,36	9,81	12,27
Surface	A (cm ²)	9,07	12,10	15,12
Bending of inertia	I _y (cm ⁴)	36,32	48,45	60,56
Bending resistance	W _y (cm ³)	11,84	15,79	19,74

Table 1: Geometrical & inertial characteristics of the trapezoidal metal sheet Symdeck 50.

Thickness	t (mm)	0,75	1,00	1,25
Weight	G (kg/m ²)	7,36	9,81	12,27
Surface	A (cm ² /m)	9,07	12,10	15,12
Bending of inertia	I _y (cm ⁴ /m)	36,32	48,45	60,56
Bending resistance	W _y (cm ³ /m)	11,84	15,79	19,74

Table 2: Geometrical & inertial characteristics of the trapezoidal metal sheet Symdeck 50 per meter of cross-sectional width.

Characteristics of Metal Sheet Symdeck 73

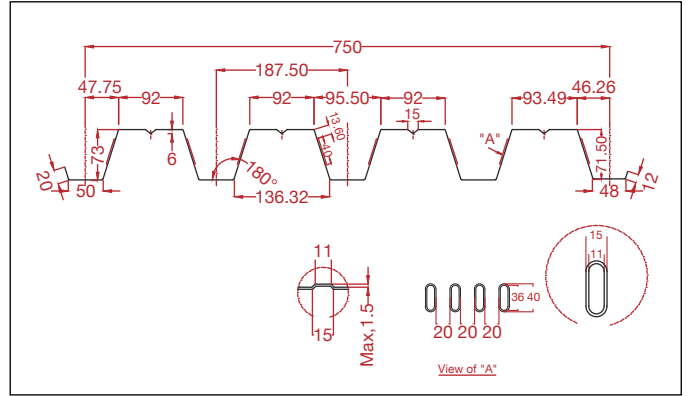
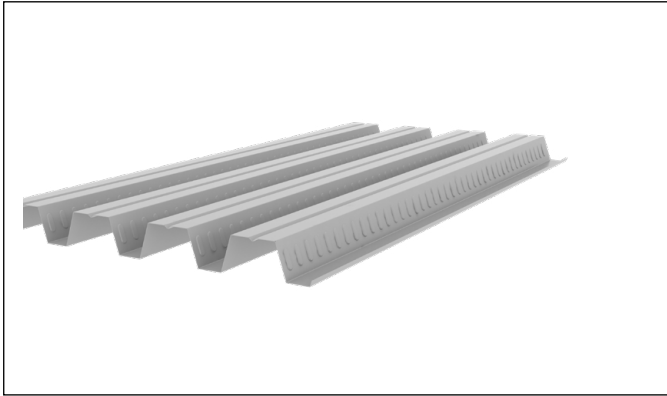

Opening: 1250 mm **Thickness:** 0,75 mm - 1,25 mm **Cover:** 750 ± 7,3 mm **Depth:** 73 ± 1,5 mm **Step:** 187,5 ± 3 mm

Thickness	t (mm)	0,75	1,00	1,25
Weight	G (kg/m)	7,36	9,81	12,27
Surface	A (cm ²)	9,57	12,72	15,98
Bending of inertia	I _y (cm ⁴)	82,51	110,42	138,32
Bending resistance	W _y (cm ³)	20,68	27,74	34,67

Table 1: Geometrical & inertial characteristics of the trapezoidal metal sheet Symdeck 73.

Thickness	t (mm)	0,75	1,00	1,25
Weight	G (kg/m ²)	9,81	13,08	16,36
Surface	A (cm ² /m)	12,76	16,96	21,31
Bending of inertia	I _y (cm ⁴ /m)	110,01	147,22	184,43
Bending resistance	W _y (cm ³ /m)	27,57	36,99	42,23

Table 2: Geometrical & inertial characteristics of the trapezoidal metal sheet Symdeck 73 per meter of cross-sectional width.

Characteristics of Metal Sheet Symdeck 100

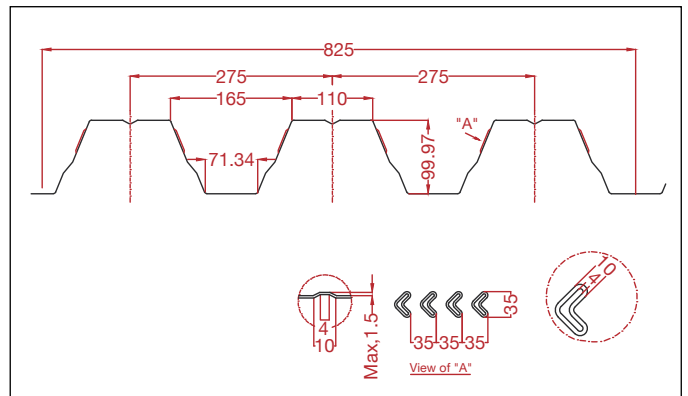
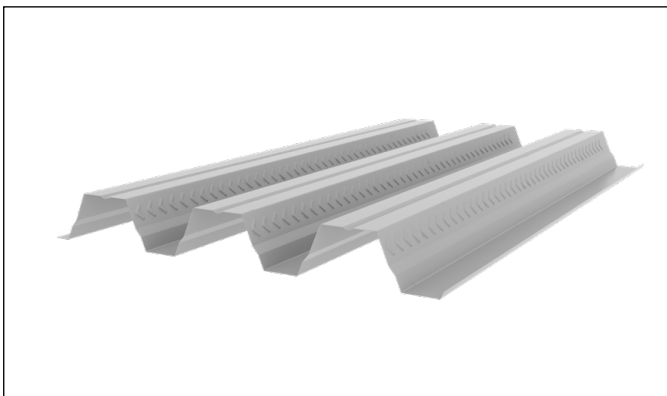

Opening: 1250 mm **Thickness:** 0,75 mm - 1,50 mm **Cover:** 825 ± 10 mm **Depth:** 100 ± 1,5 mm **Step:** 275 ± 3 mm

Thickness	t (mm)	0,75	1,00	1,25	1,50
Weight	G (kg/m)	7,36	9,81	12,27	14,72
Surface	A (cm ²)	8,87	11,82	14,77	17,73
Bending of inertia	I _y (cm ⁴)	137,39	183,15	228,95	274,76
Bending resistance	W _y (cm ³)	30,53	40,69	50,87	61,05

Table 1: Geometrical & inertial characteristics of the trapezoidal metal sheet Symdeck 100.

Thickness	t (mm)	0,75	1,00	1,25	1,50
Weight	G (kg/m ²)	8,92	11,89	14,87	17,84
Surface	A (cm ² /m)	10,99	14,65	18,31	21,97
Bending of inertia	I _y (cm ⁴ /m)	170,25	226,96	283,71	340,47
Bending resistance	W _y (cm ³ /m)	37,83	50,43	63,04	75,66

Table 2: Geometrical & inertial characteristics of the trapezoidal metal sheet Symdeck 100 per meter of cross-sectional width.

Design of composite slabs

The design of composite decks according to Eurocode 4 includes two phases, the «construction phase» and the «phase of the composite action». During the construction phase, i.e. before the hardening of the concrete, the structural system should have the ability to receive the load of the wet concrete and the extra loads that occur due to the construction.

The receiving agent of the induced tension is the bare steel sheet with the supports, basically is the metal type of the plate. After the hardening of the concrete the steel sheeting and the concrete work together as unified cross section. In this phase of the composite action, the extra loads applied on the deck during the construction lifetime, are undertaken by the composite action of the two materials.

Construction Phase

In this phase the design is based on the serviceability and ultimate limit states. In the serviceability state, it is checked that the deflections caused by the design loads are within the limits set in Eurocode 4. In the ultimate limit state, the ability of the steel sheeting to undertake the bending moments caused by the design loads is checked. The ultimate limit state is checked using the provisions of the Part 1.3 of Eurocode 3 that refers to the cold formed thin gauge members and sheeting. In case

that the required checks are not fulfilled for a given steel sheet thickness, there is the possibility to place additional intermediate supports and repeat the required checks. Also, the bending arrows that are created must be within the limits of Eurocode 3.

Composite phase

In the composite phase, checks are carried out regarding the ability to receive the intensity of the plate against negative and positive bending moment as well as against vertical and longitudinal shear.

Also, the deformations of the composite plate are checked, which should be compatible with predefined limits. The above design in the face of failure limit states aims to prevent the forms of failure described in the previous.

Failure forms of composite deck

The composite decks may fail under one of the failure modes described below:

- Bending failure (critical cross-section I).
- Longitudinal shear failure (critical cross-section II).
- Vertical shear failure (critical cross-section III).

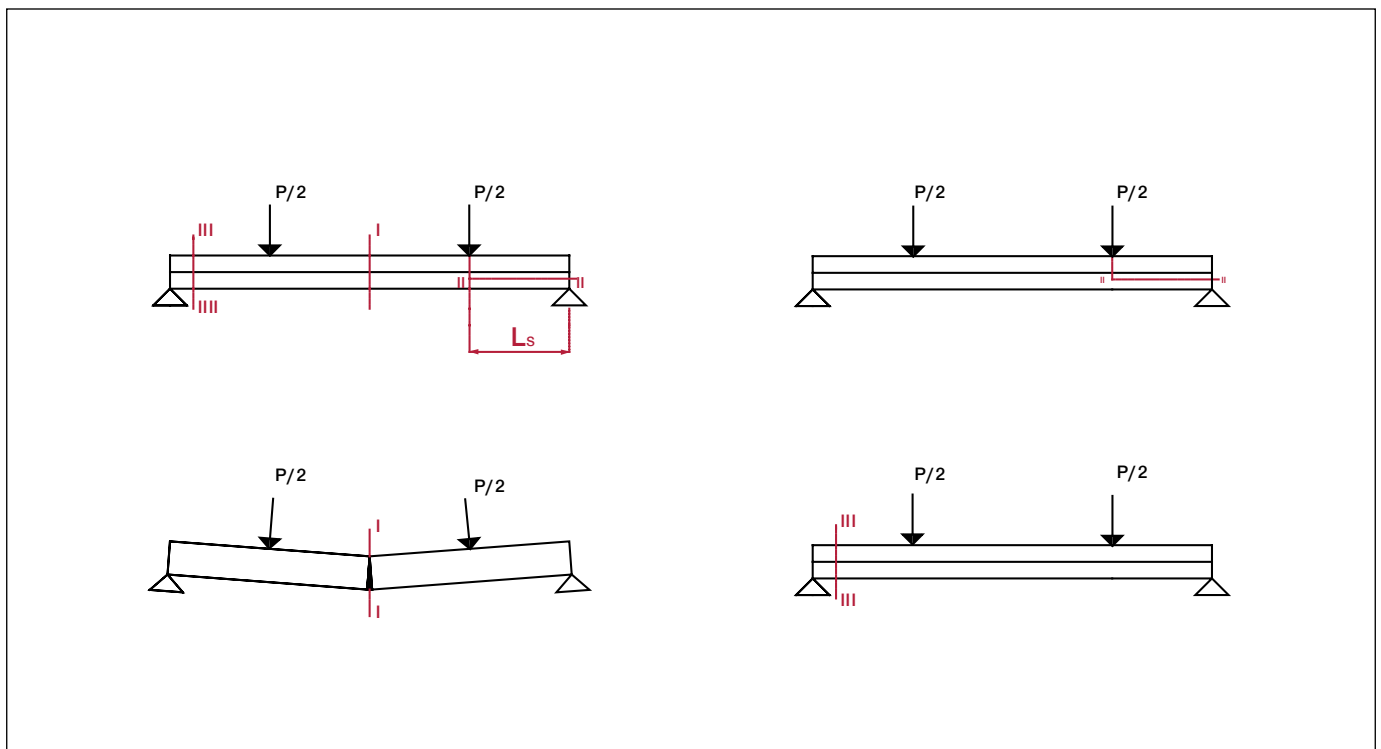

Figure 3: Failure forms of composite decks.

Design of composite slabs

Bending Failure

The bending failure is achieved only when the full shear connection between the steel sheeting and the concrete is attained. In this case, critical is the cross-section in the middle of the span (cross-section I) where vertical cracking appears.

Longitudinal shear failure

When the longitudinal shear forces that develop in the interface between the steel and the concrete cannot be fully undertaken, the bending strength of the cross section cannot be attained.

On the contrary, critical is the horizontal cross-section along the shear length L_s in one of the two supports (cross-section II) in which slippage occurs between the steel sheeting and concrete. Obviously, the failure in this case occurs for a load smaller than the one for which the bending failure is produced.

Vertical shear failure

The vertical shear failure is critical in composite decks having rather small span lengths, significant cross section height and relatively high loads. Critical is the cross-section III.

The steel sheeting plays an important role to the behavior and to the failure modes of composite decks because it is the factor that determines the type of the shear connection between the steel and the concrete.

According to Eurocode 4, the resistance of the composite deck against longitudinal shear depends on the particular parameters m, k , which are defined through appropriate experimental testing.

The experimental procedure is specified and described in detail in Eurocode 4. The specimens are simply supported composite decks as presented in Figure 4.

The simply supported composite deck is loaded with two concentrated loads in an equal distance from the supports so that the shear span of the deck is equal to $L_s=L/4$.

Two groups of three tests are conducted (A, B). In group A the specimens have a large shear span while in group B they have a small one. The diagram in Figure 5 defines the way that the factors m and k are determined from the results of the conducted experiments.

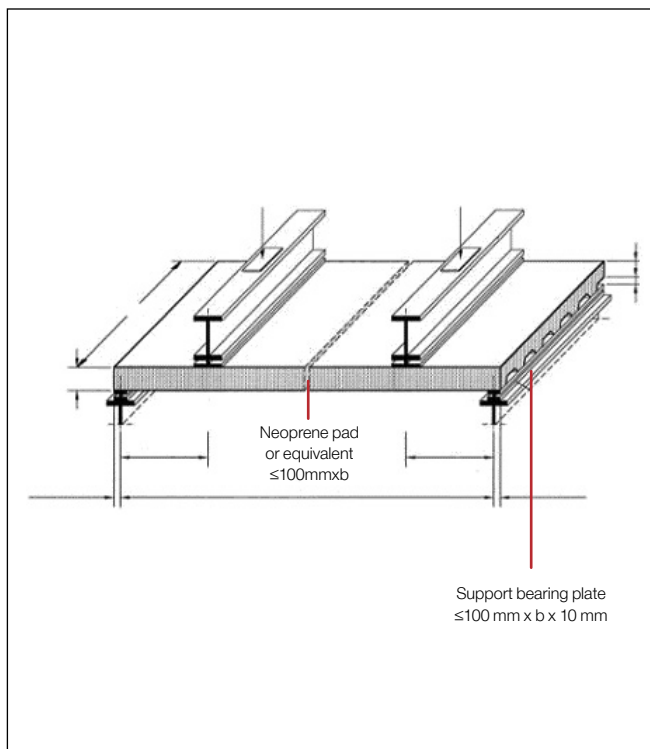

Figure 4: Determination of the parameters m, k .

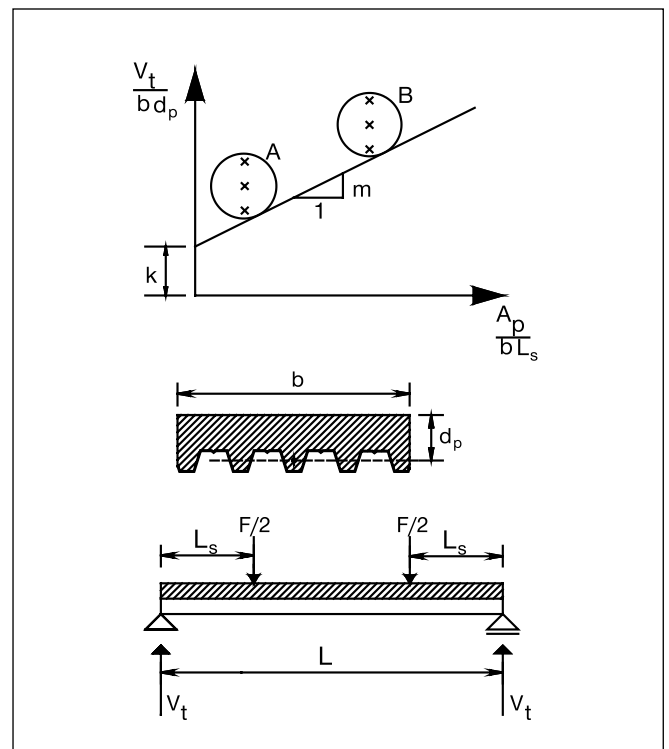

Figure 5: Determination of the parameters m, k .

Design tables Symdeck 50

Project execution team

Athanasios Triantafyllou

Prof. of Civil Engineering of the University of Patras

E-mail: ttriant@upatras.gr

Tel: 2610 996 516 & 693 275 1161

Leonidas Latsos

Civil Engineer of the University of Patras

MDE "Anti-earthquake design of structures" EAP

Kyriakos Karlos

Mechanical Engineer

MDE «Anti-earthquake design of structures»

Dept. of Civil Engineering of the University of Patras

(participation in the conduction of experimental tests)

University of Patras

Dept. of Civil Engineering

Structural Materials Laboratory

Patras 26504

Specifically, for longitudinal shear control it is necessary to determine the coefficients m and k , through four-point bending experiments. These inspections were carried out in the Laboratory of Materials Engineering and Technology of the Department of Civil Engineering of the University of Patra and gave $m=74.18$ MPa and $k= 0,0082$ MPa based on the results summarized in Fig.6. These rates apply:

- For slab thickness equal to or less than that of the inspections ($h \leq 0,18$ m).
- For thicknesses of steel sheets equal to or greater than those of the inspections ($t \geq 0,75$ mm).
- For strength class concretes C20/25 and up.
- For steel sheets with f_y 320MPa.

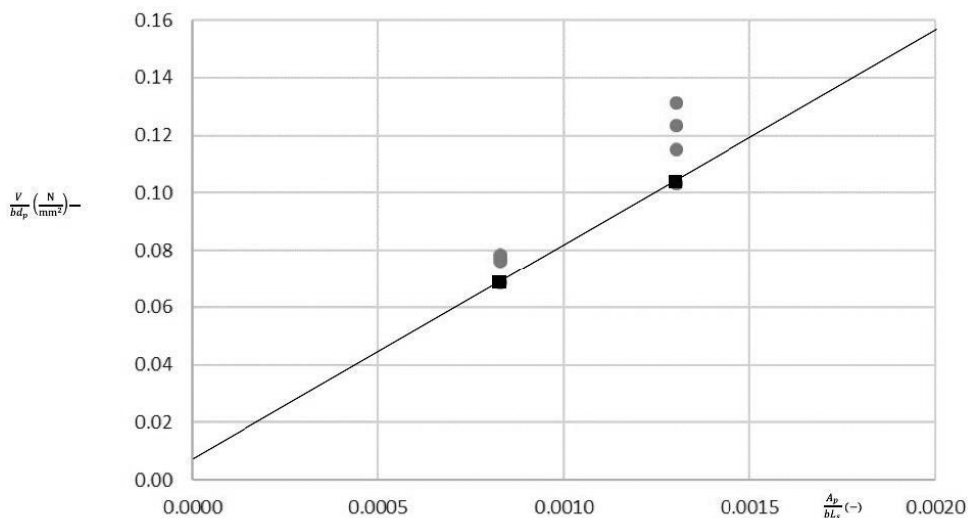

Calculation of coefficients m-k from the experimental results for SYMDECK 50.

Design tables Symdeck 50

From the following tables the following possibilities are given:

- For a given opening L it is possible to find the slab thickness that satisfies a specific limit load requirement.
- Given the thickness of the slab, it is possible to determine the opening that satisfies a specific limit load requirement.
- Given the thickness of the slab, it is possible to determine the opening that meets the limit load requirement.

The tables indicate the possible need for temporary support of the steel sheet during the concreting phase as well as the number of supports required.

The boards are valid for grade concrete C20/25 and grade reinforcement steel on the supports B500C, at a distance of 30 mm from the upper surface of the slab.

The strength moments for the construction phase are calculated in accordance with section 1.3 of Eurocode 3 taking into account only the active areas of the steel sheet at the locations where compressive stresses develop.

It is also noted that in accordance with Eurocode 4, when calculating the strength moments, the areas of the steel sheet impressions are not taken into account (i.e. the existence of a hole in the place of the impression is considered).

At the construction stage, where the bare steel sheet bears the same weight, the same weight of fresh concrete and the other loads of paving, the need for temporary support is deemed necessary in case the bending moments from the above loads are greater than the bending moments of strength of the steel sheet.

For the calculation of the moment strengths, the surrounding bending moment of the carrier is extracted during the construction phase, according to the loads specified by Eurocode 4, i.e. the same weight of steel sheet, the same base of fresh concrete for panel laying (completion of concreting per opening or openings, depending on the disadvantage) or gradual laying (concreting in successive layers that occupy the entire length of the slab), and paving load (evenly distributed load of 1,5 kN/m² on a 3x3 surface or the opening, if this is smaller, and 0,75 kN/m² in the remaining area to cause adverse effects, depending on whether the maximum positive or negative bending moment is calculated).

The inspections performed during the construction phase are: control of bending moments in opening and support, control of local transverse force in both extreme and intermediate support, control in combination of bending moment and support reaction, and finally, control in deformations (control functionality).

In the operating phase the static system of the carrier is what results after the removal of three intermediate supports. The loads acting on the composite plate are the same weight and useful load across the carrier surface.

The failure limit inspections are performed for positive and initial bending moment, for transverse shear and for longitudinal shear.

To control the limit state of functionality, the maximum arrow is calculated per opening, considering elastic behavior and stiffness equal to the average of the stiffnesses of the cracked and uncut section, and is compared to $L/250$, where L = the length of the opening.

The determination of the maximum useful load that the composite plate can carry is based on the critical control of the carrier for failure and functionality.

In the following tables this load is given in kN/m² for three different static systems (plate of one, two and three openings) and for a range of openings from 1,00 to 4,50m.

Design tables Symdeck 50

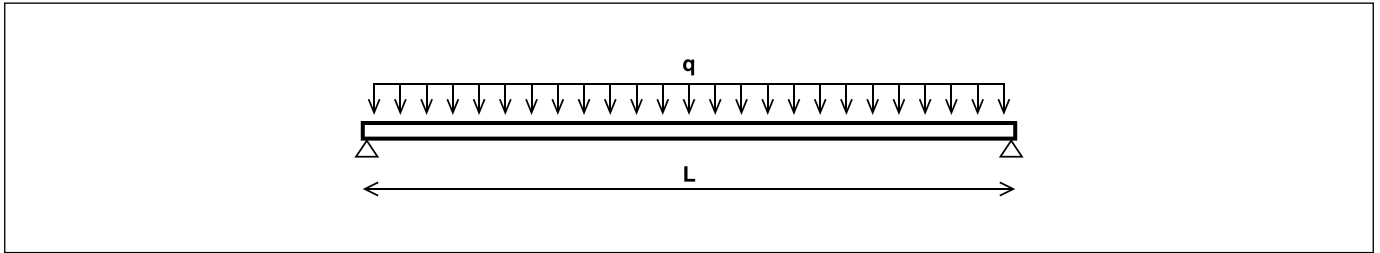

Steel sheet thickness: $t=0,75\text{mm}$

Plate thickness	Span L (m)														
h (m)	1,00	1,25	1,50	1,75	2,00	2,25	2,50	2,75	3,00	3,25	3,50	3,75	4,00	4,25	4,50
0,13	26,62	16,46	10,78	7,33	5,09	3,55	2,44	1,62	0,99	0,50	0,11				
0,14	28,32	18,14	11,88	8,10	5,63	3,93	2,71	1,81	1,12	0,58	0,15				
0,15	29,96	19,82	12,99	8,86	6,17	4,31	2,98	1,99	1,24	0,65	0,18				
0,16	31,55	21,51	14,10	9,62	6,70	4,69	3,25	2,18	1,36	0,72	0,22				
0,17	33,09	23,19	15,21	10,38	7,24	5,07	3,52	2,37	1,49	0,80	0,25				
0,18	34,59	24,87	16,32	11,15	7,78	5,46	3,79	2,55	1,61	0,87	0,28				

Steel sheet thickness: $t=1,00\text{mm}$

Plate thickness	Span L (m)														
h (m)	1,00	1,25	1,50	1,75	2,00	2,25	2,50	2,75	3,00	3,25	3,50	3,75	4,00	4,25	4,50
0,13	29,46	22,46	14,92	10,36	7,39	5,34	3,88	2,79	1,97	1,32	0,80	0,39			
0,14	31,36	24,53	16,45	11,43	8,16	5,92	4,30	3,11	2,20	1,48	0,92	0,46			
0,15	33,18	25,95	17,99	12,51	8,94	6,49	4,73	3,42	2,42	1,65	1,03	0,53			
0,16	34,95	27,32	19,52	13,58	9,71	7,06	5,15	3,73	2,65	1,81	1,14	0,60			
0,17	36,68	28,65	21,06	14,66	10,49	7,63	5,57	4,05	2,88	1,98	1,25	0,67			
0,18	38,35	29,95	22,59	15,73	11,27	8,20	5,99	4,36	3,11	2,14	1,37	0,74			

Steel sheet thickness: $t=1,25\text{mm}$

Plate thickness	Span L (m)														
h (m)	1,00	1,25	1,50	1,75	2,00	2,25	2,50	2,75	3,00	3,25	3,50	3,75	4,00	4,25	4,50
0,13	31,85	24,95	19,05	13,37	9,67	7,13	5,31	3,96	2,93	2,13	1,49	0,98	0,55	0,20	
0,14	33,91	26,55	21,01	14,75	10,69	7,89	5,89	4,40	3,27	2,39	1,68	1,12	0,65	0,26	
0,15	35,89	28,10	22,90	16,14	11,70	8,65	6,46	4,84	3,61	2,64	1,87	1,25	0,75	0,32	
0,16	37,82	29,59	24,11	17,53	12,72	9,41	7,04	5,28	3,94	2,90	2,06	1,39	0,84	0,38	
0,17	39,69	31,04	25,28	18,92	13,73	10,17	7,61	5,72	4,28	3,15	2,26	1,53	0,94	0,44	
0,18	41,51	32,46	26,42	20,30	14,75	10,93	8,19	6,16	4,61	3,41	2,45	1,67	1,03	0,50	

Intermediate support is required.

Design tables Symdeck 50

Reinforcement at the positions of bending moments

h (m)	0,13	0,14	0,15	0,16	0,17	0,18
Diameter (mm) / Space (mm)	Ø8/200	Ø8/200	Ø8/150	Ø8/150	Ø10/200	Ø10/200

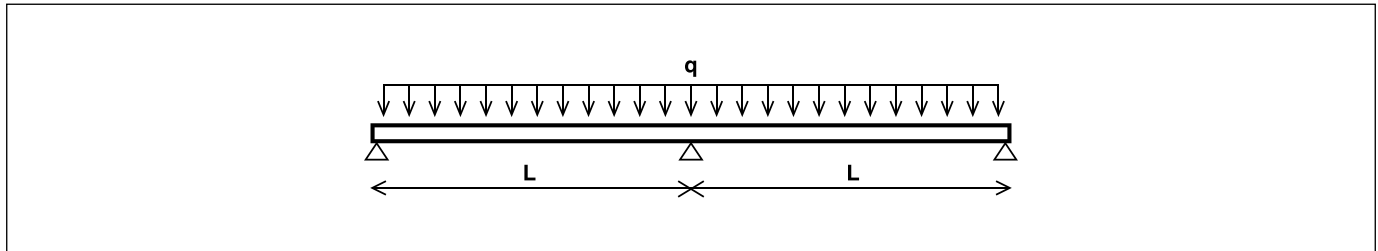

Steel sheet thickness: t=0,75mm

Plate thickness	Span L (m)														
h (m)	1,00	1,25	1,50	1,75	2,00	2,25	2,50	2,75	3,00	3,25	3,50	3,75	4,00	4,25	4,50
0,13	13,91	10,64	8,45	6,89	5,73	4,82	3,55	2,54	1,77	1,17	0,69				
0,14	15,27	11,68	9,28	7,57	6,29	5,29	3,93	2,82	1,97	1,31	0,78				
0,15	16,93	12,96	10,32	8,43	7,01	5,91	4,31	3,10	2,17	1,45	0,87				
0,16	18,37	14,07	11,20	9,15	7,62	6,42	4,69	3,38	2,37	1,59	0,96				
0,17	19,73	15,11	12,03	9,83	8,19	6,90	5,07	3,66	2,57	1,73	1,05				
0,18	21,18	16,23	12,92	10,57	8,80	7,42	5,46	3,93	2,77	1,87	1,15				

Steel sheet thickness: t=1,00mm

Plate thickness	Span L (m)														
h (m)	1,00	1,25	1,50	1,75	2,00	2,25	2,50	2,75	3,00	3,25	3,50	3,75	4,00	4,25	4,50
0,13	13,83	10,55	8,37	6,81	5,64	4,73	4,00	3,35	2,43	1,72	1,15	0,69	0,31		
0,14	15,18	11,59	9,20	7,49	6,21	5,21	4,41	3,72	2,71	1,92	1,30	0,79	0,37		
0,15	16,84	12,88	10,23	8,34	6,92	5,82	4,94	4,09	2,99	2,13	1,44	0,89	0,44		
0,16	18,28	13,98	11,11	9,07	7,53	6,34	5,38	4,46	3,26	2,33	1,59	0,99	0,50		
0,17	19,65	15,03	11,95	9,75	8,10	6,82	5,79	4,83	3,54	2,54	1,74	1,09	0,56		
0,18	21,09	16,14	12,84	10,48	8,71	7,34	6,24	5,20	3,82	2,74	1,89	1,19	0,62		

Steel sheet thickness: t=1,25mm

Plate thickness	Span L (m)														
h (m)	1,00	1,25	1,50	1,75	2,00	2,25	2,50	2,75	3,00	3,25	3,50	3,75	4,00	4,25	4,50
0,13	13,74	10,47	8,28	6,72	5,55	4,65	3,92	3,32	2,66	1,88	1,26	0,76	0,35	0,01	
0,14	15,09	11,50	9,11	7,40	6,12	5,12	4,32	3,67	3,08	2,20	1,51	0,94	0,48	0,10	
0,15	16,76	12,79	10,15	8,26	6,84	5,74	4,86	4,13	3,53	3,02	2,39	1,70	1,14	0,67	
0,16	18,19	13,89	11,03	8,98	7,44	6,25	5,29	4,51	3,86	3,31	2,63	1,88	1,27	0,76	
0,17	19,56	14,94	11,86	9,66	8,02	6,73	5,71	4,87	4,17	3,57	2,86	2,06	1,40	0,85	
0,18	21,01	16,06	12,75	10,39	8,63	7,25	6,15	5,25	4,50	3,86	3,09	2,23	1,53	0,94	

Design tables Symdeck 50

Reinforcement at the positions of bending moments

h (m)	0,13	0,14	0,15	0,16	0,17	0,18
Diameter (mm) / Space (mm)	Ø8/200	Ø8/200	Ø8/150	Ø8/150	Ø10/200	Ø10/200

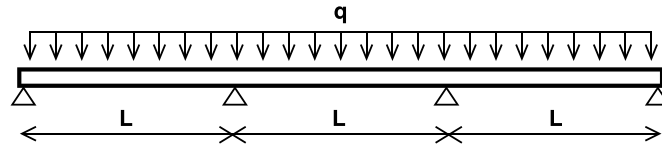

Steel sheet thickness: $t=0,75\text{mm}$

Plate thickness	Span L (m)														
h (m)	1,00	1,25	1,50	1,75	2,00	2,25	2,50	2,75	3,00	3,25	3,50	3,75	4,00	4,25	4,50
0,13	14,59	11,18	8,91	7,28	6,07	4,91	3,55	2,54	1,77	1,17	0,69				
0,14	16,01	12,27	9,78	8,00	6,66	5,43	3,93	2,82	1,97	1,31	0,78				
0,15	17,58	13,48	10,75	8,80	7,33	5,95	4,31	3,10	2,17	1,45	0,87				
0,16	19,09	14,65	11,68	9,57	7,98	6,47	4,69	3,38	2,37	1,59	0,96				
0,17	20,69	15,88	12,67	10,38	8,67	6,99	5,07	3,66	2,57	1,73	1,05				
0,18	22,21	17,05	13,61	11,15	9,31	7,50	5,46	3,93	2,77	1,87	1,15				

Steel sheet thickness: $t=1,00\text{mm}$

Plate thickness	Span L (m)														
h (m)	1,00	1,25	1,50	1,75	2,00	2,25	2,50	2,75	3,00	3,25	3,50	3,75	4,00	4,25	4,50
0,13	14,51	11,10	8,82	7,20	5,98	5,03	4,28	3,35	2,43	1,72	1,15	0,69	0,31		
0,14	15,93	12,19	9,69	7,91	6,58	5,54	4,71	3,72	2,71	1,92	1,30	0,79	0,37		
0,15	17,49	13,40	10,66	8,71	7,25	6,11	5,20	4,09	2,99	2,13	1,44	0,89	0,44		
0,16	19,01	14,56	11,60	9,48	7,89	6,66	5,67	4,46	3,26	2,33	1,59	0,99	0,50		
0,17	20,61	15,80	12,59	10,30	8,58	7,24	6,18	4,83	3,54	2,54	1,74	1,09	0,56		
0,18	22,12	16,96	13,53	11,07	9,23	7,79	6,65	5,20	3,82	2,74	1,89	1,19	0,62		

Steel sheet thickness: $t=1,25\text{mm}$

Plate thickness	Span L (m)														
h (m)	1,00	1,25	1,50	1,75	2,00	2,25	2,50	2,75	3,00	3,25	3,50	3,75	4,00	4,25	4,50
0,13	14,42	11,01	8,74	7,11	5,90	4,95	4,19	3,57	3,05	2,62	1,92	1,35	0,88	0,49	
0,14	15,84	12,10	9,61	7,83	6,49	5,45	4,62	3,94	3,38	2,90	2,16	1,53	1,01	0,58	
0,15	17,59	13,45	10,70	8,73	7,25	6,10	5,19	4,43	3,81	3,24	2,39	1,70	1,14	0,67	
0,16	19,09	14,61	11,62	9,49	7,89	6,65	5,65	4,84	4,16	3,55	2,63	1,88	1,27	0,76	
0,17	20,52	15,71	12,50	10,21	8,50	7,16	6,09	5,22	4,49	3,85	2,86	2,06	1,40	0,85	
0,18	22,04	16,88	13,44	10,98	9,14	7,71	6,56	5,62	4,84	4,16	3,09	2,23	1,53	0,94	

Intermediate support is required.

Design tables Symdeck 73

Project Execution Team

Head of the experiment

E. Mystakidis

Prof. of Static, Director of the Laboratory of Construction Analysis and Design

E-mail: emistaki@uth.gr

Tel.: 24 210 74171, 6974 718 682

Head of experimental part

F. Perdikaris

Prof. of Reinforced Concrete, Director of the Laboratory of Reinforced Concrete Technology and Construction

E-mail: filperd@uth.gr

Tel.: 24210 74151

Software Development

K. Dimitriadis

Civil Engineer of U.TH.

Scientific personnel

O. Panagouli

Associate professor U.TH.

K. Tzaros

Dr. Civil Engineer of U.TH.

D. Pantousa

Dr. Civil Engineer of U.TH.

A. Giannopoulos

Civil Engineer of U.TH.

K. Papachristou

Civil Engineer U.TH.

The design tables were prepared in the Department of Civil Engineering of the University of Thessaly in the framework of the Research Program «Determination of design loads of composite slabs with corrugated steel sheets», on behalf of the company ELASTRON SA.

The values of parameters m, k were determined after a set of experiments on composite decks which were conducted in the Laboratory of Reinforced Concrete Technology and Structures of the Department of Civil Engineering at the University of Thessaly, Greece, within the framework of a relevant research program. The values were calculated by means of the diagram of Figure 7.

These parameters are effective for:

- Deck thickness equal or smaller than the one used in tests ($d \leq 20\text{cm}$).
- Steel sheeting thickness equal or greater than the one used in tests ($t \geq 0,75\text{mm}$).
- Concrete with characteristic compressive strength $f_{ck} \geq 20\text{ Mpa}$ (C20/25 and above).
- Profile steel sheeting with yield stress $f_y \geq 293\text{ Mpa}$ (practically S320GD and above).

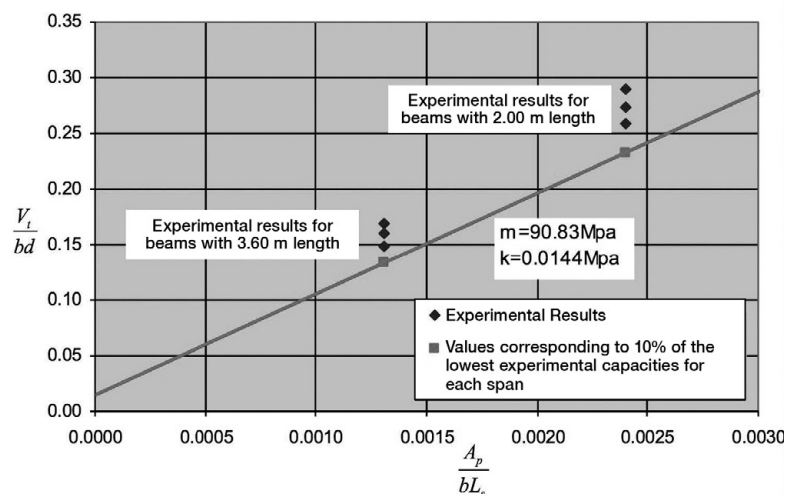

Determination of the parameters $m-k$ from the experimental results for SYMDECK 73.

Design tables Symdeck 73

The tables which have been created for various SYMDECK 73 steel sheeting thickness, concrete qualities and structural systems give the following abilities:

- Determination of the deck thickness required for a certain span length and a certain ultimate load.
- Determination of the maximum span length for a certain value of the deck thickness and a certain ultimate load.
- Determination of the maximum ultimate load for a certain deck thickness and a certain span length.

Also, the tables indicate the need for temporary intermediate supports of the steel sheeting during the construction phase and the number of the required supports.

The creation of the sizing tables was based on the SYMDECK Designer software which determined both the need for temporary support in the openings that was deemed necessary during the construction phase and the marginal useful load that the composite plate can carry during the operation phase.

In the construction phase, the bending strengths were calculated according to the Part 1.3 of Eurocode 3, taking into account only the effective areas of the steel sheeting in the places where compressive stresses develop. It is noted that during the calculation of the bending strengths, the areas of the embossments of the steel sheeting are neglected (it is considered that an opening replaces the embossment).

The above assumption is required by Eurocode 4.

During the construction phase, when the steel sheeting supports its self-weight, the weight of the wet concrete and the extra construction loads. A temporary support is essential when the design bending moments due to the above loads are greater than the bending moment resistance of the steel sheeting.

For the determination of the design bending moments, the envelope of the moments produced by the various load situations is used according to the load specified by Eurocode 4. For the determination of the envelope of the bending moments, the following loads are applied:

- Self weight of the steel sheeting G_p (permanent load).
- Self weight of the concrete (permanent load). Two cases are taken into account in order to consider the self weight of the concrete:

a) The case of a span-by-span casting (first a span is casted with the prescribed concrete thickness, and the casting continues in another span)

b) Progressive casting (the deck is casted in layers until the prescribed deck thickness is attained).

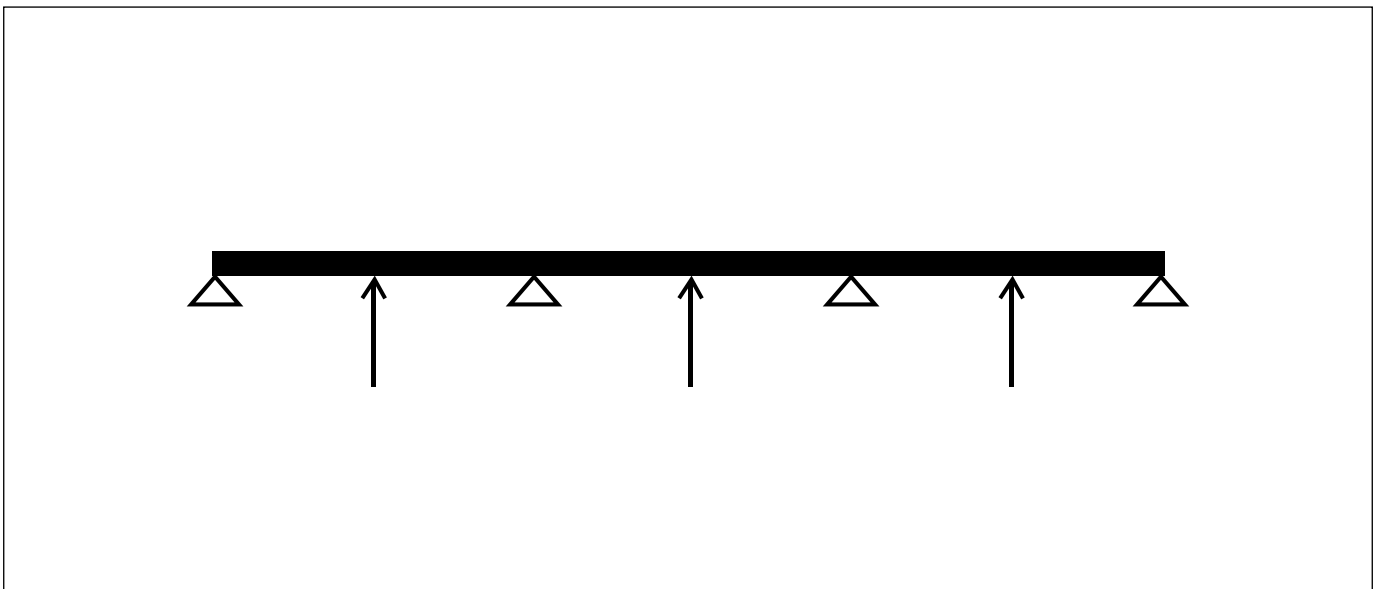

Figure 8: Composite slab model with intermediate supports.

Design tables Symdeck 73

- Laying load (variable load).
- The laying load is a uniformly distributed load 1,5 kN/m² acting on a surface of 3mx3m (or as long as the opening if it is shorter) and a uniformly distributed load 0,75 kN/m² acting on the remaining area, depending on whether the maximum negative or positive bending moment action is calculated.
- For the above loads, the most unfavorable load is considered, as shown in Figures 9 and 10.

For the serviceability limit state, a load safety factor equal to 1.00 is considered.

In case that the design bending moment is greater than the bending strength of the steel sheet, the calculations are repeated with a structural system having intermediate supports.

In the tables that follow, the span lengths requiring one intermediate support are indicated with pink colour. In the composite phase the structural system of the composite deck is the initial one, i.e. the one resulting after the removal of the intermediate supports. In this phase, the applied loads in the composite deck are the self-weight G, as well as the variable load Q.

For the determination of the internal forces of the composite deck due to the above mentioned loads it is assumed that the variable load Q is applied on the entire area of the deck.

Two states are considered:

Ultimate limit state

It is based on the loading combination 1.35G + 1.50Q from which the internal forces E_{Sd} are obtained (resistance against sagging moments M_{Sd}^+ , resistance against hogging moments M_{Sd}^- , resistance against vertical shear $V_{Sd,v}$ and resistance against longitudinal shear $V_{Sd,l}$).

Serviceability limit state

It is based on the load combination 1.00G+1.00Q for which the elastic line of the carrier is calculated. For the calculation of the displacements, an average value of stiffness of the cracked and the uncracked cross section is used.

The definition of the ultimate variable load Q of the above relations is based on the critical state of the carrier. Critical state of the carrier is considered to be the one for which:

- None of the design forces exceeds the respective resistance.
- The displacements of the composite deck are in every span smaller than L/250, where L is the span length.

In the following tables the ultimate variable loads Q of the composite decks were calculated for three different structural systems and for span lengths varying between 1,00 m and 5,50m.

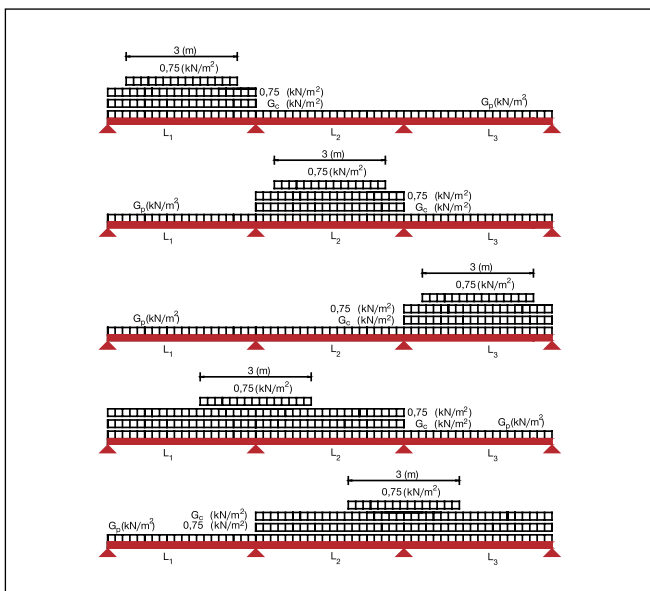

Figure 9: Sliding load compilations.

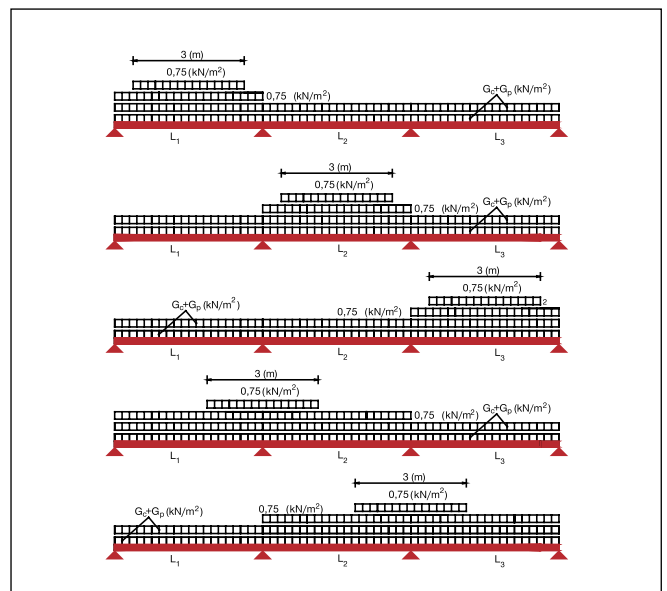
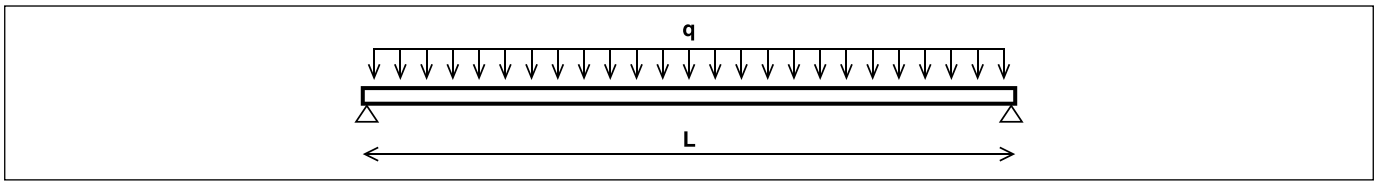

Figure 10: Sliding load combinations.

Design tables Symdeck 73



Steel sheet thickness: $t=0,75\text{mm}$

Concrete: C20/25 Steel Reinforcement: B500C

Plate thickness	Span L (m)																		
h_f (m)	1,00	1,25	1,50	1,75	2,00	2,25	2,50	2,75	3,00	3,25	3,50	3,75	4,00	4,25	4,50	4,75	5,00	5,25	5,50
0,13	28,72	22,61	16,95	12,06	8,85	6,64	5,06	3,88	2,98	2,28	1,72	1,26	0,89	0,58					
0,14	30,83	24,21	18,92	13,44	9,87	7,40	5,64	4,32	3,32	2,54	1,91	1,41	0,99	0,65					
0,15	32,82	25,72	20,86	14,82	10,88	8,17	6,22	4,77	3,66	2,80	2,11	1,55	1,10	0,71					
0,16	34,72	27,22	22,12	16,02	11,89	8,93	6,80	5,21	4,00	3,06	2,31	1,70	1,20	0,78					
0,17	36,55	28,71	23,26	17,58	12,90	9,69	7,37	5,66	4,35	3,32	2,51	1,85	1,30	0,85					
0,18	38,40	30,09	24,44	18,96	13,92	10,45	7,95	6,10	4,69	3,58	2,70	1,99	1,41	0,92	0,51				
0,19	40,13	31,43	25,54	20,13	14,93	11,21	8,53	6,55	5,03	3,85	2,90	2,14	1,51	0,99	0,55				
0,20	41,89	32,65	26,72	21,67	15,94	11,97	9,11	6,99	5,37	4,11	3,10	2,28	1,61	1,06	0,59				

Maximum values of the variable load Q (kN/m²)

Steel sheet thickness: $t=0,80\text{mm}$

Concrete: C20/25 Steel Reinforcement: B500C

Plate thickness	Span L (m)																		
h_f (m)	1,00	1,25	1,50	1,75	2,00	2,25	2,50	2,75	3,00	3,25	3,50	3,75	4,00	4,25	4,50	4,75	5,00	5,25	5,50
0,13	29,25	23,00	17,87	12,84	9,45	7,11	5,44	4,19	3,24	2,50	1,91	1,43	1,03	0,71					
0,14	31,27	24,79	20,07	14,31	10,53	7,92	6,06	4,67	3,63	2,79	2,13	1,59	1,16	0,79					
0,15	33,55	26,15	21,55	15,78	11,61	8,74	6,68	5,15	3,98	3,07	2,35	1,76	1,28	0,87	0,54				
0,16	35,41	27,79	22,82	17,25	12,69	9,55	7,31	5,63	4,35	3,36	2,57	1,93	1,40	0,96	0,59				
0,17	37,23	29,11	23,96	18,52	13,77	10,37	7,93	6,11	4,73	3,65	2,79	2,09	1,52	1,04	0,64				
0,18	39,02	30,70	25,18	19,98	14,85	11,18	8,56	6,59	5,10	3,93	3,01	2,26	1,64	1,12	0,69				
0,19	40,79	32,06	26,08	21,56	15,94	12,00	9,18	7,07	5,47	4,22	3,23	2,42	1,76	1,21	0,74				
0,20	42,52	33,55	27,19	22,75	17,02	12,81	9,80	7,56	5,85	4,51	3,45	2,59	1,88	1,29	0,80				

Maximum values of the variable load Q (kN/m²)

Steel sheet thickness: $t=1,00\text{mm}$

Concrete: C20/25 Steel Reinforcement: B500C

Plate thickness	Span L (m)																		
h_f (m)	1,00	1,25	1,50	1,75	2,00	2,25	2,50	2,75	3,00	3,25	3,50	3,75	4,00	4,25	4,50	4,75	5,00	5,25	5,50
0,13	31,77	24,92	20,51	16,38	12,20	9,30	7,21	5,65	4,46	3,53	2,80	2,20	1,71	1,31	0,96	0,67			
0,14	33,98	26,89	22,01	18,17	13,60	10,37	8,03	6,30	4,97	3,94	3,12	2,46	1,91	1,46	1,08	0,75			
0,15	36,16	28,55	23,38	19,75	15,03	11,44	8,86	6,95	5,49	4,35	3,45	2,71	2,12	1,61	1,19	0,83	0,53		
0,16	38,19	29,98	24,73	20,70	16,32	12,50	9,68	7,60	6,00	4,76	3,77	2,97	2,32	1,76	1,31	0,92	0,58		
0,17	40,20	31,58	25,86	21,94	17,76	13,57	10,51	8,25	6,52	5,17	4,10	3,23	2,52	1,92	1,42	1,00	0,64		
0,18	42,38	33,46	27,28	22,86	19,04	14,63	11,34	8,90	7,03	5,58	4,42	3,48	2,72	2,07	1,54	1,08	0,69		
0,19	44,53	34,91	28,37	23,96	20,55	15,70	12,17	9,55	7,55	5,99	4,74	3,74	2,92	2,23	1,65	1,16	0,74		
0,20	46,45	36,44	29,74	24,95	21,32	16,73	13,00	10,20	8,06	6,39	5,07	4,00	3,12	2,38	1,77	1,24	0,80		

Maximum values of the variable load Q (kN/m²)

Steel sheet thickness: $t=1,25\text{mm}$

Concrete: C20/25 Steel Reinforcement: B500C

Plate thickness	Span L (m)																		
h_f (m)	1,00	1,25	1,50	1,75	2,00	2,25	2,50	2,75	3,00	3,25	3,50	3,75	4,00	4,25	4,50	4,75	5,00	5,25	5,50
0,13	34,31	27,05	22,20	18,72	15,44	11,94	9,34	7,41	5,94	4,79	3,87	3,13	2,53	2,03	1,60	1,24	0,94	0,67	
0,14	36,90	29,01	23,88	20,02	17,27	13,31	10,41	8,26	6,62	5,35	4,32	3,50	2,83	2,27	1,80	1,39	1,05	0,76	0,51
0,15	39,06	30,75	25,35	21,47	18,39	14,59	11,48	9,11	7,31	5,90	4,77	3,87	3,12	2,51	1,99	1,55	1,17	0,84	0,57
0,16	41,68	32,77	26,89	22,62	19,49	15,89	12,56	9,97	8,00	6,45	5,23	4,23	3,42	2,75	2,18	1,70	1,28	0,93	0,62
0,17	43,88	34,36	28,28	23,85	20,47	17,26	13,64	10,82	8,68	7,01	5,68	4,60	3,72	2,99	2,37	1,85	1,40	1,01	0,68
0,18	45,94	34,12	29,51	24,95	21,44	18,77	14,67	11,6	9,37	7,56	6,13	4,97	4,02	3,22	2,56	2,00	1,52	1,10	0,74
0,19	47,97	37,96	30,99	26,05	22,40	19,56	15,64	12,5	10,05	8,12	6,58	5,33	4,31	3,46	2,75	2,15	1,63	1,18	0,80
0,20	49,87	39,58	32,25	27,20	23,13	20,30	16,79	13,35	10,7	8,67	7,03	5,70	4,61	3,70	2,94	2,30	1,75	1,27	0,86

Maximum values of the variable load Q (kN/m²)

☐ One intermediate support is required.

Design tables Symdeck 73

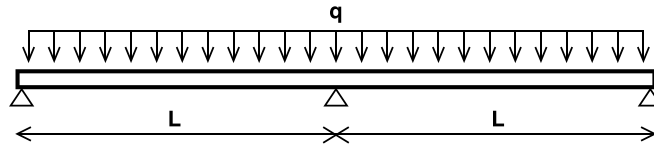

Reinforcement at the positions of bending moments

h_t (m)	0,13	0,14	0,15	0,16	0,17	0,18	0,19	0,20
Diameter (mm) / Space (mm)	Ø8/200	Ø8/200	Ø8/150	Ø8/150	Ø10/200	Ø10/200	Ø10/150	Ø10/150

Steel sheet thickness: $t=0,75\text{mm}$

Concrete: C20/25 Steel Reinforcement: B500C

Plate thickness	Span L (m)																		
h_t (m)	1,00	1,25	1,50	1,75	2,00	2,25	2,50	2,75	3,00	3,25	3,50	3,75	4,00	4,25	4,50	4,75	5,00	5,25	5,50
0,13	22,58	17,67	14,36	10,43	7,58	5,63	4,22	3,18	2,38	1,76	1,26	0,86	0,53						
0,14	24,04	18,77	15,38	11,62	8,45	6,27	4,71	3,54	2,66	1,96	1,41	0,96	0,60						
0,15	25,74	20,05	16,28	12,70	9,32	6,92	5,19	3,91	2,93	2,17	1,56	1,07	0,66						
0,16	27,24	21,26	17,28	13,95	10,19	7,56	5,67	4,27	3,21	2,37	1,71	1,17	0,72						
0,17	28,70	22,34	18,14	15,05	11,06	8,21	6,16	4,64	3,48	2,57	1,85	1,27	0,79						
0,18	30,09	23,41	18,99	15,75	11,92	8,85	6,64	5,00	3,75	2,78	2,00	1,37	0,85						
0,19	31,46	24,46	19,83	16,53	12,79	9,50	7,13	5,37	4,03	2,98	2,15	1,47	0,92						
0,20	32,80	25,49	20,65	17,20	13,66	10,14	7,61	5,74	4,30	3,18	2,3	1,57	0,98						

Maximum values of the variable load Q (kN/m²)

Steel sheet thickness: $t=0,80\text{mm}$

Concrete: C20/25 Steel Reinforcement: B500C

Plate thickness	Span L (m)																		
h_t (m)	1,00	1,25	1,50	1,75	2,00	2,25	2,50	2,75	3,00	3,25	3,50	3,75	4,00	4,25	4,50	4,75	5,00	5,25	5,50
0,13	23,00	18,1	14,74	11,12	8,12	6,04	4,56	3,46	2,61	1,96	1,43	1,01	0,66						
0,14	24,79	19,35	15,75	12,29	9,04	6,74	5,08	3,85	2,92	2,18	1,60	1,13	0,74						
0,15	26,25	20,58	16,66	13,64	9,97	7,43	5,61	4,25	3,22	2,41	1,77	1,25	0,82						
0,16	27,89	21,78	17,54	14,77	10,90	8,12	6,09	4,65	3,52	2,64	1,94	1,37	0,90	0,52					
0,17	29,21	22,88	18,51	15,48	11,83	8,82	6,65	5,05	3,82	2,86	2,10	1,49	0,98	0,56					
0,18	30,60	23,93	19,46	16,28	12,73	9,51	7,18	5,45	4,12	3,09	2,27	1,60	1,06	0,60					
0,19	32,06	25,05	20,29	16,96	13,61	10,20	7,70	5,84	4,43	3,32	2,44	1,72	1,14	0,65					
0,20	33,56	26,11	21,11	17,63	14,57	10,89	8,23	6,24	4,73	3,54	2,60	1,84	1,22	0,70					

Maximum values of the variable load Q (kN/m²)

Steel sheet thickness: $t=1,00\text{mm}$

Concrete: C20/25 Steel Reinforcement: B500C

Plate thickness	Span L (m)																		
h_t (m)	1,00	1,25	1,50	1,75	2,00	2,25	2,50	2,75	3,00	3,25	3,50	3,75	4,00	4,25	4,50	4,75	5,00	5,25	5,50
0,13	25,02	19,69	15,91	13,36	10,08	7,54	5,72	4,38	3,36	2,56	1,93	1,42	1,00	0,66					
0,14	26,89	21,03	17,02	14,31	11,25	8,46	6,43	4,92	3,78	2,89	2,18	1,61	1,14	0,76					
0,15	28,55	22,35	18,22	15,21	12,94	9,82	7,54	5,85	4,55	3,55	2,75	2,10	1,57	1,12	0,75				
0,16	30,28	23,55	19,25	16,16	13,75	10,69	8,25	6,39	4,98	3,88	3,01	2,30	1,72	1,23	0,83				
0,17	31,90	24,85	20,25	16,95	14,45	11,65	8,95	6,94	5,41	4,22	3,27	2,50	1,87	1,34	0,90	0,53			
0,18	33,25	26,00	21,25	17,66	15,15	12,48	9,66	7,49	5,84	4,55	3,52	2,70	2,01	1,45	0,97	0,57			
0,19	34,81	27,22	22,15	18,34	15,8	13,35	10,36	8,04	6,27	4,88	3,78	2,90	2,16	1,56	1,05	0,62			
0,20	36,34	28,44	23,10	19,10	16,43	14,20	10,95	8,59	6,69	5,22	4,04	3,10	2,31	1,67	1,12	0,66			

Maximum values of the variable load Q (kN/m²)

Steel sheet thickness: $t=1,25\text{mm}$

Concrete: C20/25 Steel Reinforcement: B500C

Plate thickness	Span L (m)																		
h_t (m)	1,00	1,25	1,50	1,75	2,00	2,25	2,50	2,75	3,00	3,25	3,50	3,75	4,00	4,25	4,50	4,75	5,00	5,25	5,50
0,13	27,24	21,39	17,48	14,60	12,60	9,95	7,67	5,99	4,71	3,71	2,92	2,28	1,76	1,32	0,96				
0,14	29,10	22,89	18,70	15,71	13,46	11,20	8,69	6,79	5,34	4,22	3,33	2,61	2,02	1,53	1,12	0,77			
0,15	30,80	24,14	19,84	16,68	14,28	12,36	9,71	7,59	5,98	4,73	3,73	2,93	2,27	1,73	1,27	0,89	0,56		
0,16	32,57	25,73	20,91	17,59	15,05	13,10	10,70	8,39	6,62	5,24	4,14	3,26	2,53	1,93	1,43	1,00	0,64		
0,17	34,26	27,05	21,96	18,39	15,77	13,75	11,65	9,16	7,33	5,85	4,67	3,72	2,93	2,29	1,74	1,28	0,88	0,54	
0,18	35,95	28,15	23,15	19,27	16,55	14,25	12,55	9,92	7,91	6,31	5,04	4,01	3,17	2,47	1,88	1,38	0,96	0,59	
0,19	37,60	29,52	24,15	20,04	17,25	14,82	13,10	10,67	8,49	6,78	5,41	4,31	3,41	2,66	2,03	1,49	1,03	0,64	
0,20	39,28	30,78	25,00	20,90	17,98	15,55	13,55	11,40	9,05	7,24	5,79	4,61	3,64	2,84	2,17	1,60	1,11	0,69	

Maximum values of the variable load Q (kN/m²)

One intermediate support is required.

Design tables Symdeck 73

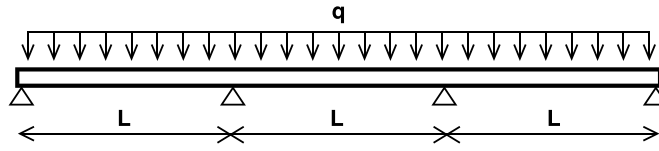

Reinforcement at the positions of bending moments

h_t (m)	0,13	0,14	0,15	0,16	0,17	0,18	0,19	0,20
Diameter (mm) / Space (mm)	Ø8/200	Ø8/200	Ø8/150	Ø8/150	Ø10/200	Ø10/200	Ø10/150	Ø10/150

Steel sheet thickness: $t=0,75\text{mm}$

Concrete: C20/25 Steel Reinforcement: B500C

Plate thickness	Span L (m)																		
h_t (m)	1,00	1,25	1,50	1,75	2,00	2,25	2,50	2,75	3,00	3,25	3,50	3,75	4,00	4,25	4,50	4,75	5,00	5,25	5,50
0,13	23,53	18,52	14,95	10,95	7,98	5,94	4,48	3,39	2,56	1,92	1,40	0,98	0,64						
0,14	25,29	19,75	16,06	12,2	8,90	6,63	5,00	3,78	2,86	2,14	1,56	1,10	0,71						
0,15	26,93	20,95	17,11	13,42	9,81	7,31	5,51	4,17	3,15	2,36	1,72	1,21	0,79						
0,16	28,44	22,05	18,10	14,70	10,72	7,99	6,02	4,56	3,45	2,58	1,89	1,33	0,87						
0,17	29,82	23,20	19,05	15,75	11,64	8,67	6,54	4,95	3,75	2,80	2,05	1,44	0,94	0,53					
0,18	31,18	24,35	19,95	16,65	12,55	9,35	7,05	5,34	4,04	3,02	2,21	1,56	1,02	0,57					
0,19	32,82	25,60	20,75	17,35	13,47	10,03	7,56	5,73	4,34	3,24	2,37	1,67	1,09	0,61					
0,20	34,22	26,73	21,60	18,05	14,37	10,71	8,08	6,12	4,59	3,47	2,54	1,79	1,17	0,66					

Maximum values of the variable load Q (kN/m²)

Steel sheet thickness: $t=0,80\text{mm}$

Concrete: C20/25 Steel Reinforcement: B500C

Plate thickness	Span L (m)																		
h_t (m)	1,00	1,25	1,50	1,75	2,00	2,25	2,50	2,75	3,00	3,25	3,50	3,75	4,00	4,25	4,50	4,75	5,00	5,25	5,50
0,13	24,06	18,97	15,40	11,67	8,54	6,38	4,83	3,68	2,81	2,12	1,58	1,14	0,77						
0,14	25,82	20,17	16,55	12,95	9,51	7,11	5,39	4,11	3,13	2,37	1,76	1,27	0,87	0,53					
0,15	27,55	21,55	17,55	14,30	10,49	7,84	5,94	4,53	3,45	2,61	1,94	1,40	0,96	0,59					
0,16	29,16	22,72	18,50	15,55	11,47	8,57	6,50	4,95	3,78	2,86	2,13	1,54	1,05	0,64					
0,17	30,64	23,86	19,45	16,30	12,45	9,31	7,05	5,38	4,10	3,10	2,31	1,67	1,14	0,70					
0,18	32,10	25,08	20,40	17,10	13,40	10,04	7,61	5,80	4,43	3,35	2,49	1,80	1,23	0,76					
0,19	33,63	26,28	21,35	17,80	14,35	10,77	8,16	6,23	4,75	3,60	2,68	1,93	1,32	0,82					
0,20	35,14	27,36	22,20	18,45	15,35	11,50	8,72	6,65	5,07	3,84	2,86	2,07	1,42	0,87					

Maximum values of the variable load Q (kN/m²)

Steel sheet thickness: $t=1,00\text{mm}$

Concrete: C20/25 Steel Reinforcement: B500C

Plate thickness	Span L (m)																		
h_t (m)	1,00	1,25	1,50	1,75	2,00	2,25	2,50	2,75	3,00	3,25	3,50	3,75	4,00	4,25	4,50	4,75	5,00	5,25	5,50
0,13	26,24	20,51	16,8	14,12	11,02	8,40	6,47	5,03	3,94	3,08	2,40	1,85	1,40	1,03	0,71				
0,14	28,09	21,98	18,00	15,10	12,35	9,37	7,21	5,61	4,39	3,44	2,68	2,07	1,57	1,15	0,80	0,50			
0,15	29,91	23,45	19,05	16,05	13,53	10,33	7,96	6,19	4,85	3,80	2,96	2,29	1,73	1,27	0,89	0,56			
0,16	31,51	24,63	20,15	16,95	14,46	11,30	8,70	6,77	5,30	4,16	3,24	2,50	1,90	1,40	0,97	0,61			
0,17	33,28	25,96	21,25	17,70	15,20	12,25	9,45	7,35	5,76	4,51	3,52	2,72	2,06	1,52	1,06	0,67			
0,18	34,93	27,18	22,25	18,60	15,90	13,09	10,19	7,93	6,21	4,87	3,80	2,94	2,23	1,64	1,15	0,73			
0,19	36,25	28,57	23,15	19,45	16,59	14,05	10,95	8,51	6,67	5,23	4,08	3,16	2,40	1,76	1,23	0,78			
0,20	37,94	29,74	24,05	20,22	17,18	14,94	11,65	9,09	7,12	5,59	4,36	3,37	2,56	1,89	1,32	0,84			

Maximum values of the variable load Q (kN/m²)

Steel sheet thickness: $t=1,25\text{mm}$

Concrete: C20/25 Steel Reinforcement: B500C

Plate thickness	Span L (m)																		
h_t (m)	1,00	1,25	1,50	1,75	2,00	2,25	2,50	2,75	3,00	3,25	3,50	3,75	4,00	4,25	4,50	4,75	5,00	5,25	5,50
0,13	28,46	22,36	18,29	15,39	13,20	10,85	8,45	6,65	5,30	4,25	3,40	2,72	2,15	1,70	1,31	0,98	0,70		
0,14	30,48	23,93	19,58	16,46	14,10	12,10	9,41	7,43	5,92	4,74	3,80	3,02	2,42	1,90	1,47	1,10	0,78		
0,15	32,45	25,45	20,67	17,45	14,95	12,95	10,32	8,20	6,53	5,23	4,20	3,36	2,67	2,10	1,62	1,21	0,87	0,57	
0,16	34,08	26,90	21,89	18,40	15,80	13,75	11,35	8,97	7,14	5,72	4,59	3,67	2,92	2,30	1,78	1,33	0,95	0,63	
0,17	35,84	28,25	23,08	19,25	16,50	14,45	12,30	9,67	7,76	6,21	4,99	4,00	3,18	2,50	1,94	1,45	1,04	0,69	
0,18	37,67	29,70	24,25	20,30	17,25	15,10	13,25	10,45	8,37	6,71	5,38	4,31	3,43	2,71	2,09	1,57	1,13	0,75	
0,19	39,36	30,95	25,30	21,20	18,00	15,65	13,80	11,25	8,99	7,20	5,78	4,63	3,69	2,91	2,25	1,69	1,22	0,81	
0,20	40,96	32,22	26,27	22,10	18,88	16,20	14,25	12,02	9,57	7,69	6,18	4,95	3,95	3,11	2,41	1,81	1,30	0,87	

Maximum values of the variable load Q (kN/m²)

☐ One intermediate support is required.

Design Tables Symdeck 100

Project execution team

Athanasios Trianatafyllou

Prof. of Civil Engineering of the University of Patras

E-mail: ttriant@upatras.gr

Tel.: 2610 996 516 & 693 275 1161

Leonidas Latsos

Civil Engineer of the University of Patras

MDE «Anti-earthquake design of structures» EAP

Kyriakos Karlos

Mechanical Engineer

MDE «Anti-earthquake design of structures»

Dept. of Civil Engineering of the University of Patras

(participation in the conduction of experimental tests)

University of Patras

Dept. of Civil Engineering

Structural Materials Laboratory

Patras 26504

Specifically, for longitudinal shear control it is necessary to determine the coefficients m and k , through four-point bending experiments. These inspections were carried out in the Laboratory of Materials Engineering and Technology of the Department of Civil Engineering of the University of Patras and gave $m = 83,08$ MPa and $k = 0,0032$ MPa based on the results summarized in Fig.11. These rates apply:

- For slab thickness equal to or less than that of the inspections ($h \leq 0,22$ m).
- For thicknesses of steel sheets equal to or greater than those of the inspections ($t \geq 0,75$ mm).
- For strength class concretes C20/25 and up.
- For steel sheets with $f_y \geq 320$ MPa.

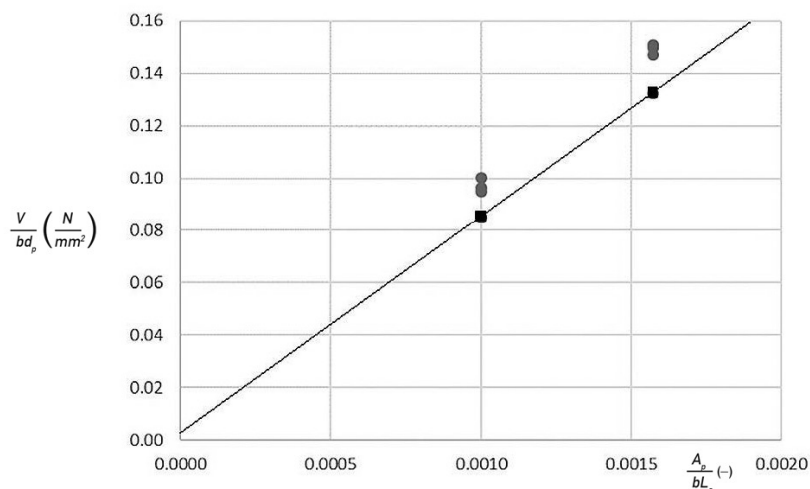

Calculation of coefficients m-k from the experimental results for SYMDECK 100.

Design Tables Symdeck 100

From the following tables the following possibilities are given:

- For a given opening L it is possible to find the slab thickness that satisfies a specific limit load requirement.
- Given the thickness of the slab, it is possible to determine the opening that satisfies a specific limit load requirement.
- Given the thickness of the slab, it is possible to determine the opening that meets the limit load requirement.

The tables indicate the possible need for temporary support of the steel sheet during the concreting phase as well as the number of supports required.

The boards are valid for grade concrete C20/25 and grade reinforcement steel on the supports B500C, at a distance of 30 mm from the upper surface of the slab.

The strength moments for the construction phase are calculated in accordance with section 1.3 of Eurocode 3 taking into account only the active areas of the steel sheet at the locations where compressive stresses develop.

It is also noted that in accordance with Eurocode 4, when calculating the strength moments, the areas of the steel sheet impressions are not taken into account (i.e., the existence of a hole in the place of the impression is considered).

At the construction stage, where the bare steel sheet bears the same weight, the same weight of fresh concrete and the other loads of paving, the need for temporary support is deemed necessary in case the bending moments from the above loads are greater than the bending moments of strength of the steel sheet.

For the calculation of the moment strengths, the surrounding bending moment of the carrier is extracted during the construction phase, according to the loads specified by Eurocode 4, i.e. the same weight of steel sheet, the same base of fresh concrete for panel laying (completion of concreting per opening or openings, depending on the disadvantage) or gradual laying (concreting in successive layers that occupy the entire length of the slab), and paving load (evenly distributed load of $1,5 \text{ kN/m}^2$ on a $3 \times 3 \text{ m}$ surface or as the opening if this is smaller, and $0,75 \text{ kN/m}^2$ in the remaining area in order to cause adverse effects, depending on whether the maximum positive or negative bending

moment is calculated).

The inspections performed during the construction phase are: control of bending moments in opening and support, control of local transverse force in both extreme and intermediate support, control in combination of bending moment and support reaction, and finally, control in deformations (control functionality).

In the operating phase the static system of the carrier is what results after the removal of three intermediate supports. The loads acting on the composite plate bear the same weight and the useful movable load across the whole carrier surface.

The failure limit inspections are performed for positive and initial bending moment, for transverse shear and for longitudinal shear.

To control the limit state of functionality, the maximum arrow is calculated per opening, considering elastic behavior and stiffness equal to the average of the stiffnesses of the cracked and uncut section, and is compared to $L/250$, where L = the length of the opening.

The determination of the maximum useful load that the composite plate can carry is based on the critical control of the carrier for failure and functionality.

In the following tables this load is given in kN/m^2 for three different static systems (plate of one, two and three openings) and for a range of openings from 1,00 m to 5,50 m.

Design Tables Symdeck 100

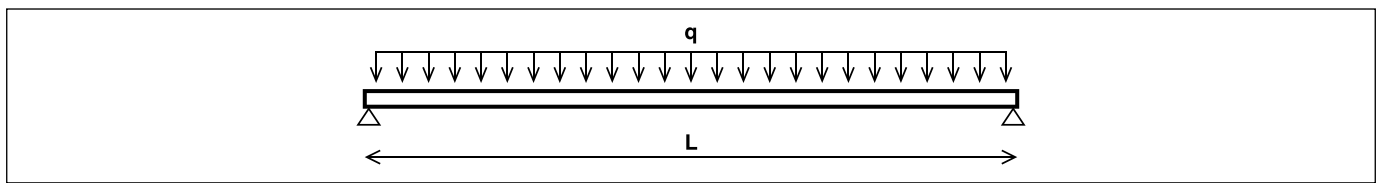

Steel sheet thickness: t=0,75mm

Plate thickness	Span L (m)																		
h (m)	1,00	1,25	1,50	1,75	2,00	2,25	2,50	2,75	3,00	3,25	3,50	3,75	4,00	4,25	4,50	4,75	5,00	5,25	5,50
0,15	37,80	24,05	16,01	11,16	8,00	5,84	4,29	3,14	2,27	1,59	1,05	0,61							
0,16	40,08	26,35	17,54	12,23	8,77	6,40	4,70	3,44	2,49	1,74	1,15	0,67							
0,17	42,30	28,65	19,07	13,29	9,54	6,96	5,11	3,75	2,71	1,90	1,25	0,73							
0,18	44,46	30,94	20,60	14,36	10,30	7,52	5,53	4,05	2,93	2,05	1,35	0,79							
0,19	46,55	33,24	22,13	15,42	11,07	8,08	5,94	4,35	3,14	2,20	1,46	0,85							
0,20	48,59	35,53	23,66	16,49	11,83	8,64	6,35	4,65	3,36	2,36	1,56	0,91							
0,21	50,59	37,83	25,19	17,56	12,60	9,20	6,76	4,96	3,58	2,51	1,66	0,98							
0,22	52,54	40,12	26,72	18,62	13,37	9,76	7,17	5,26	3,80	2,67	1,77	1,04							

Steel sheet thickness: t=1,00mm

Plate thickness	Span L (m)																		
h (m)	1,00	1,25	1,50	1,75	2,00	2,25	2,50	2,75	3,00	3,25	3,50	3,75	4,00	4,25	4,50	4,75	5,00	5,25	5,50
0,15	41,74	32,67	21,97	15,51	11,31	8,43	6,37	4,85	3,69	2,78	2,06	1,48	1,01	0,61	0,28				
0,16	44,29	34,89	24,07	17,00	12,40	9,25	6,99	5,32	4,05	3,06	2,27	1,64	1,12	0,68	0,32				
0,17	46,75	36,81	26,18	18,49	13,49	10,07	7,61	5,80	4,41	3,34	2,48	1,79	1,22	0,75	0,36				
0,18	49,14	38,68	28,29	19,98	14,58	10,88	8,23	6,27	4,78	3,61	2,69	1,94	1,33	0,82	0,40				
0,19	51,47	40,50	30,39	21,47	15,67	11,70	8,85	6,74	5,14	3,89	2,90	2,10	1,44	0,90	0,44				
0,20	53,74	42,27	32,50	22,96	16,76	12,51	9,47	7,22	5,50	4,17	3,11	2,25	1,55	0,97	0,48				
0,21	55,96	44,00	34,60	24,45	17,86	13,33	10,09	7,69	5,87	4,44	3,31	2,40	1,66	1,04	0,52				
0,22	58,13	45,69	36,71	25,94	18,95	14,15	10,71	8,17	6,23	4,72	3,52	2,56	1,76	1,11	0,56				

Steel sheet thickness: t=1,25mm

Plate thickness	Span L (m)																		
h (m)	1,00	1,25	1,50	1,75	2,00	2,25	2,50	2,75	3,00	3,25	3,50	3,75	4,00	4,25	4,50	4,75	5,00	5,25	5,50
0,15	45,07	35,54	27,92	19,86	14,62	11,03	8,46	6,55	5,10	3,98	3,08	2,36	1,76	1,27	0,86				
0,16	47,82	37,70	30,61	21,77	16,04	12,10	9,28	7,20	5,61	4,38	3,39	2,60	1,95	1,41	0,96				
0,17	50,49	39,79	32,65	23,69	17,45	13,17	10,11	7,84	6,12	4,78	3,71	2,85	2,14	1,56	1,07				
0,18	53,09	41,82	34,31	25,60	18,87	14,25	10,94	8,49	6,63	5,18	4,02	3,09	2,33	1,70	1,17				
0,19	55,61	43,79	35,92	27,52	20,28	15,32	11,77	9,14	7,13	5,58	4,34	3,34	2,52	1,84	1,27				
0,20	58,08	45,72	37,48	29,43	21,70	16,39	12,59	9,78	7,64	5,98	4,65	3,58	2,71	1,98	1,38				
0,21	60,48	47,60	39,01	31,34	23,11	17,46	13,42	10,43	8,15	6,38	4,97	3,83	2,90	2,13	1,48				
0,22	62,84	49,44	40,50	33,26	24,53	18,53	14,25	11,07	8,66	6,78	5,28	4,08	3,09	2,27	1,58				

Steel sheet thickness: t=1,50mm

Plate thickness	Span L (m)																		
h (m)	1,00	1,25	1,50	1,75	2,00	2,25	2,50	2,75	3,00	3,25	3,50	3,75	4,00	4,25	4,50	4,75	5,00	5,25	5,50
0,15	46,40	36,59	30,05	24,23	17,95	13,64	10,56	8,27	6,54	5,19	4,11	3,24	2,54	1,95	1,45	1,04	0,68	0,37	0,10
0,16	50,85	40,11	32,94	26,56	19,69	14,97	11,59	9,09	7,19	5,71	4,53	3,58	2,81	2,16	1,62	1,16	0,77	0,44	0,14
0,17	53,77	42,39	34,81	28,90	21,42	16,30	12,63	9,91	7,84	6,23	4,95	3,92	3,08	2,38	1,79	1,29	0,87	0,50	0,18
0,18	56,54	44,56	36,58	30,88	23,16	17,62	13,66	10,73	8,49	6,75	5,37	4,26	3,35	2,59	1,95	1,42	0,96	0,56	0,22
0,19	59,24	46,68	38,30	32,32	24,90	18,95	14,69	11,54	9,14	7,28	5,79	4,60	3,62	2,80	2,12	1,54	1,05	0,63	0,26
0,20	61,87	48,74	39,98	33,73	26,64	20,28	15,73	12,36	9,80	7,80	6,21	4,93	3,89	3,02	2,29	1,67	1,15	0,69	0,30
0,21	64,44	50,75	41,62	35,10	28,38	21,61	16,76	13,18	10,45	8,32	6,63	5,27	4,16	3,23	2,46	1,80	1,24	0,76	0,34
0,22	66,95	52,72	43,22	36,44	30,12	22,94	17,80	13,99	11,10	8,84	7,05	5,61	4,43	3,45	2,62	1,93	1,33	0,82	0,38

□ One intermediate support is required.

□ Two intermediate supports are required.

Design tables Symdeck 100

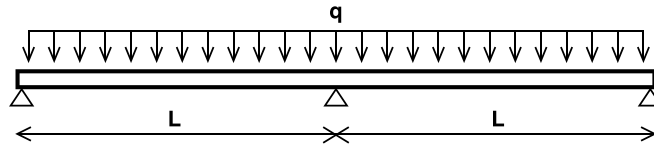

Reinforcement at the positions of bending moments

h (m)	0,15	0,16	0,17	0,18	0,19	0,20	0,21	0,22
Diameter (mm) / Space (mm)	Ø8/125	Ø8/125	Ø10/150	Ø10/150	Ø10/125	Ø10/125	Ø12/150	Ø12/150

Steel sheet thickness: t=0,75mm

Plate thickness	Span L (m)																		
h (m)	1,00	1,25	1,50	1,75	2,00	2,25	2,50	2,75	3,00	3,25	3,50	3,75	4,00	4,25	4,50	4,75	5,00	5,25	5,50
0,15	22,66	17,65	14,31	11,92	9,14	6,74	5,02	3,74	2,77	2,02	1,42	0,93	0,53	0,21					
0,16	24,48	19,06	15,45	12,87	10,01	7,38	5,50	4,10	3,04	2,21	1,55	1,02	0,59	0,23					
0,17	26,33	20,50	16,61	13,83	10,89	8,03	5,98	4,46	3,31	2,41	1,69	1,12	0,64	0,25					
0,18	28,28	22,01	17,83	14,84	11,76	8,67	6,46	4,82	3,57	2,60	1,83	1,21	0,70	0,27					
0,19	30,15	23,46	19,00	15,82	12,64	9,32	6,94	5,18	3,84	2,80	1,97	1,30	0,75	0,30					
0,20	32,15	25,02	20,26	16,86	13,51	9,96	7,42	5,54	4,11	2,99	2,11	1,39	0,81	0,32					
0,21	33,63	26,15	21,17	17,61	14,39	10,61	7,90	5,90	4,38	3,19	2,25	1,48	0,86	0,34					
0,22	35,71	27,78	22,49	18,71	15,26	11,25	8,39	6,26	4,64	3,38	2,38	1,58	0,91	0,36					

Steel sheet thickness: t=1,00mm

Plate thickness	Span L (m)																		
h (m)	1,00	1,25	1,50	1,75	2,00	2,25	2,50	2,75	3,00	3,25	3,50	3,75	4,00	4,25	4,50	4,75	5,00	5,25	5,50
0,15	22,57	17,55	14,21	11,83	10,04	8,65	7,34	5,65	4,36	3,35	2,56	1,91	1,39	0,95	0,58				
0,16	24,39	18,97	15,35	12,77	10,84	9,33	8,05	6,20	4,79	3,69	2,81	2,11	1,53	1,05	0,65				
0,17	26,24	20,40	16,51	13,73	11,65	10,03	8,73	6,75	5,21	4,02	3,07	2,30	1,67	1,15	0,72				
0,18	28,18	21,91	17,73	14,75	12,51	10,77	9,38	7,30	5,64	4,35	3,32	2,50	1,82	1,26	0,78				
0,19	30,06	23,37	18,91	15,72	13,33	11,48	9,99	7,85	6,07	4,68	3,58	2,69	1,96	1,36	0,85				
0,20	32,06	24,92	20,17	16,77	14,22	12,24	10,66	8,40	6,50	5,01	3,84	2,88	2,11	1,46	0,92				
0,21	33,53	26,06	21,08	17,52	14,85	12,77	11,11	8,95	6,92	5,34	4,09	3,08	2,25	1,56	0,99				
0,22	35,62	27,68	22,39	18,61	15,78	13,57	11,81	9,50	7,35	5,68	4,35	3,27	2,39	1,67	1,05				

Steel sheet thickness: t=1,25mm

Plate thickness	Span L (m)																		
h (m)	1,00	1,25	1,50	1,75	2,00	2,25	2,50	2,75	3,00	3,25	3,50	3,75	4,00	4,25	4,50	4,75	5,00	5,25	5,50
0,15	22,47	17,46	14,12	11,73	9,94	8,55	7,44	6,53	5,77	4,69	3,70	2,89	2,24	1,69	1,23	0,85	0,52		
0,16	24,29	18,87	15,26	12,68	10,74	9,24	8,03	7,05	6,23	5,16	4,07	3,19	2,47	1,87	1,37	0,95	0,59		
0,17	26,14	20,31	16,42	13,64	11,56	9,93	8,64	7,58	6,69	5,63	4,44	3,49	2,71	2,06	1,51	1,05	0,66		
0,18	28,09	21,82	17,64	14,65	12,42	10,67	9,28	8,14	7,19	6,10	4,82	3,79	2,94	2,24	1,65	1,15	0,73		
0,19	29,96	23,27	18,81	15,63	13,24	11,38	9,90	8,68	7,67	6,57	5,19	4,08	3,17	2,42	1,79	1,25	0,80		
0,20	31,96	24,83	20,07	16,68	14,13	12,15	10,56	9,26	8,18	7,03	5,56	4,38	3,41	2,60	1,93	1,36	0,87		
0,21	33,44	25,97	20,98	17,42	14,75	12,68	11,02	9,66	8,53	7,50	5,94	4,68	3,64	2,79	2,07	1,46	0,94		
0,22	35,52	27,59	22,30	18,52	15,68	13,48	11,72	10,27	9,07	7,97	6,31	4,97	3,88	2,97	2,21	1,56	1,01		

Steel sheet thickness: t=1,50mm

Plate thickness	Span L (m)																		
h (m)	1,00	1,25	1,50	1,75	2,00	2,25	2,50	2,75	3,00	3,25	3,50	3,75	4,00	4,25	4,50	4,75	5,00	5,25	5,50
0,15	22,39	17,38	14,04	11,65	9,87	8,47	7,36	6,45	5,69	5,05	4,50	3,89	3,10	2,45	1,90	1,44	1,04	0,70	
0,16	24,22	18,80	15,18	12,60	10,66	9,16	7,95	6,97	6,15	5,45	4,86	4,29	3,43	2,71	2,11	1,60	1,17	0,80	
0,17	26,06	20,23	16,34	13,56	11,48	9,86	8,56	7,50	6,61	5,87	5,22	4,67	3,75	2,97	2,32	1,77	1,30	0,89	
0,18	28,01	21,74	17,56	14,58	12,34	10,60	9,20	8,06	7,11	6,31	5,62	5,02	4,08	3,24	2,53	1,94	1,43	0,99	
0,19	29,88	23,19	18,74	15,55	13,16	11,30	9,82	8,60	7,59	6,73	5,99	5,36	4,40	3,50	2,74	2,10	1,55	1,08	
0,20	31,88	24,75	19,99	16,60	14,05	12,07	10,48	9,18	8,10	7,19	6,41	5,73	4,72	3,76	2,95	2,27	1,68	1,18	
0,21	33,36	25,89	20,90	17,34	14,67	12,60	10,94	9,58	8,45	7,49	6,67	5,95	5,05	4,02	3,16	2,43	1,81	1,27	
0,22	35,44	27,51	22,22	18,44	15,60	13,40	11,64	10,19	8,99	7,97	7,10	6,35	5,37	4,28	3,37	2,60	1,94	1,37	

□ One intermediate support is required.

□ Two intermediate supports are required.

Design tables Symdeck 100

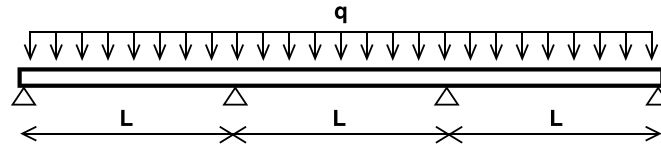

Reinforcement at the positions of bending moments

h (m)	0,15	0,16	0,17	0,18	0,19	0,20	0,21	0,22
Diameter (mm) / Space (mm)	Ø8/125	Ø8/125	Ø10/150	Ø10/150	Ø10/125	Ø10/125	Ø12/150	Ø12/150

Steel sheet thickness: t=0,75mm

Plate thickness	Span L (m)																		
h (m)	1,00	1,25	1,50	1,75	2,00	2,25	2,50	2,75	3,00	3,25	3,50	3,75	4,00	4,25	4,50	4,75	5,00	5,25	5,50
0,15	23,70	18,48	15,00	12,52	9,14	6,74	5,02	3,74	2,77	2,02	1,42	0,93	0,53	0,21					
0,16	25,61	19,97	16,20	13,51	10,01	7,38	5,50	4,10	3,04	2,21	1,55	1,02	0,59	0,23					
0,17	27,55	21,47	17,42	14,52	10,89	8,03	5,98	4,46	3,31	2,41	1,69	1,12	0,64	0,25					
0,18	29,58	23,05	18,70	15,59	11,76	8,67	6,46	4,82	3,57	2,60	1,83	1,21	0,70	0,27					
0,19	31,54	24,58	19,93	16,61	12,64	9,32	6,94	5,18	3,84	2,80	1,97	1,30	0,75	0,30					
0,20	33,64	26,21	21,25	17,71	13,51	9,96	7,42	5,54	4,11	2,99	2,11	1,39	0,81	0,32					
0,21	35,18	27,40	22,21	18,50	14,39	10,61	7,90	5,90	4,38	3,19	2,25	1,48	0,86	0,34					
0,22	37,36	29,10	23,59	19,65	15,26	11,25	8,39	6,26	4,64	3,38	2,38	1,58	0,91	0,36					

Steel sheet thickness: t=1,00mm

Plate thickness	Span L (m)																		
h (m)	1,00	1,25	1,50	1,75	2,00	2,25	2,50	2,75	3,00	3,25	3,50	3,75	4,00	4,25	4,50	4,75	5,00	5,25	5,50
0,15	23,61	18,39	14,91	12,42	10,56	9,11	7,34	5,65	4,36	3,35	2,56	1,91	1,39	0,95	0,58				
0,16	25,52	19,87	16,11	13,42	11,40	9,83	8,05	6,20	4,79	3,69	2,81	2,11	1,53	1,05	0,65				
0,17	27,45	21,37	17,32	14,43	12,26	10,57	8,77	6,75	5,21	4,02	3,07	2,30	1,67	1,15	0,72				
0,18	29,49	22,96	18,60	15,49	13,16	11,35	9,48	7,30	5,64	4,35	3,32	2,50	1,82	1,26	0,78				
0,19	31,45	24,48	19,84	16,52	14,03	12,10	10,19	7,85	6,07	4,68	3,58	2,69	1,96	1,36	0,85				
0,20	33,54	26,11	21,16	17,62	14,96	12,90	10,90	8,40	6,50	5,01	3,84	2,88	2,11	1,46	0,92				
0,21	35,09	27,30	22,11	18,41	15,63	13,46	11,61	8,95	6,92	5,34	4,09	3,08	2,25	1,56	0,99				
0,22	37,27	29,00	23,49	19,56	16,60	14,31	12,33	9,50	7,35	5,68	4,35	3,27	2,39	1,67	1,05				

Steel sheet thickness: t=1,25mm

Plate thickness	Span L (m)																		
h (m)	1,00	1,25	1,50	1,75	2,00	2,25	2,50	2,75	3,00	3,25	3,50	3,75	4,00	4,25	4,50	4,75	5,00	5,25	5,50
0,15	23,51	18,29	14,82	12,33	10,47	9,02	7,86	6,91	5,95	4,69	3,70	2,89	2,24	1,69	1,23	0,85	0,52		
0,16	25,42	19,78	16,01	13,32	11,31	9,74	8,49	7,46	6,53	5,16	4,07	3,19	2,47	1,87	1,37	0,95	0,59		
0,17	27,36	21,28	17,23	14,33	12,16	10,47	9,12	8,02	7,10	5,63	4,44	3,49	2,71	2,06	1,51	1,05	0,66		
0,18	29,39	22,86	18,51	15,40	13,07	11,25	9,80	8,62	7,63	6,10	4,82	3,79	2,94	2,24	1,65	1,15	0,73		
0,19	31,36	24,39	19,74	16,43	13,94	12,00	10,45	9,19	8,13	6,57	5,19	4,08	3,17	2,42	1,79	1,25	0,80		
0,20	33,45	26,02	21,06	17,52	14,87	12,81	11,16	9,80	8,68	7,03	5,56	4,38	3,41	2,60	1,93	1,36	0,87		
0,21	35,00	27,21	22,02	18,31	15,53	13,37	11,64	10,22	9,04	7,50	5,94	4,68	3,64	2,79	2,07	1,46	0,94		
0,22	37,18	28,91	23,40	19,46	16,51	14,21	12,38	10,87	9,62	7,97	6,31	4,97	3,88	2,97	2,21	1,56	1,01		

Steel sheet thickness: t=1,50mm

Plate thickness	Span L (m)																		
h (m)	1,00	1,25	1,50	1,75	2,00	2,25	2,50	2,75	3,00	3,25	3,50	3,75	4,00	4,25	4,50	4,75	5,00	5,25	5,50
0,15	23,43	18,22	14,74	12,25	10,39	8,94	7,78	6,83	6,04	5,37	4,79	3,89	3,10	2,45	1,90	1,44	1,04	0,70	
0,16	25,34	19,70	15,93	13,24	11,23	9,66	8,41	7,38	6,52	5,80	5,18	4,29	3,43	2,71	2,11	1,60	1,17	0,80	
0,17	27,28	21,20	17,15	14,25	12,08	10,39	9,04	7,94	7,02	6,24	5,57	4,69	3,75	2,97	2,32	1,77	1,30	0,89	
0,18	29,31	22,78	18,43	15,32	12,99	11,17	9,72	8,54	7,55	6,71	5,99	5,09	4,08	3,24	2,53	1,94	1,43	0,99	
0,19	31,28	24,31	19,66	16,35	13,86	11,92	10,37	9,11	8,05	7,16	6,39	5,49	4,40	3,50	2,74	2,10	1,55	1,08	
0,20	33,37	25,94	20,98	17,44	14,79	12,73	11,08	9,72	8,60	7,65	6,83	5,89	4,72	3,76	2,95	2,27	1,68	1,18	
0,21	34,92	27,13	21,94	18,23	15,45	13,29	11,56	10,14	8,96	7,97	7,11	6,29	5,05	4,02	3,16	2,43	1,81	1,27	
0,22	37,10	28,83	23,32	19,38	16,43	14,13	12,30	10,79	9,54	8,48	7,57	6,69	5,37	4,28	3,37	2,60	1,94	1,37	

□ One intermediate support is required.

□ Two intermediate supports are required.

Fire dimensional sizing boards

The fire inspection is based on the loading $G+\psi_2Q$ from which the intensity values are obtained (positive bending moments M_{fSd}^+ and negative bending moments M_{fSd}^-).

The calculations concern the exposure of the composite slab to the ISO fire and apply to heating rates between 2 and 50°K/min.

Resistance to positive and negative bending moments M_{fSd}^+ , M_{fSd}^- is calculated on the basis of fire temperatures (ISO), in accordance with the provisions of Eurocode 4 – Part 1.2.

The determination of the maximum load Q of the above relations is based on the critical inspection of the carrier, which can result either from the inspections at normal temperature (limit failure and functionality controls) or from the fire resistance test of the composite slab (thermal insulation criterion I, and load-bearing capacity criterion R).

The maximum load Q cannot exceed the value that the plate can bring to normal temperature. In case the plate cannot carry the load for which it satisfies the inspections at normal temperature, the diameter of the additional lower reinforcement required is indicated (placement of a bar inside the groove of the steel sheet).

In the above calculations the distance of the center of gravity of the lower reinforcement from the lower side of the composite plate is taken to be equal to 30mm. In addition, the distance of the center of the gravity of the upper reinforcement from the upper side of the composite plate is taken to be equal to 30mm. The quality of the steel of the reinforcement bars is B500C.

In case the slab satisfies the bearing capacity criterion (criterion R) but does not meet the thermal insulation criterion (criterion I) the value of the maximum load is indicated in the tables and has a sloping line.

Fire dimensional sizing boards Symdeck 50

The following tables determine the maximum useful load Q that the composite plate can carry for three different static systems, for a range of openings from 1,00 m to 4,50 m and for a coefficient value $\psi_2=0,60$.

The tables are differentiated according to the fire resistance requirement (the cases are R30, R60, R90, and R120).

Fire dimensional sizing boards Symdeck 50

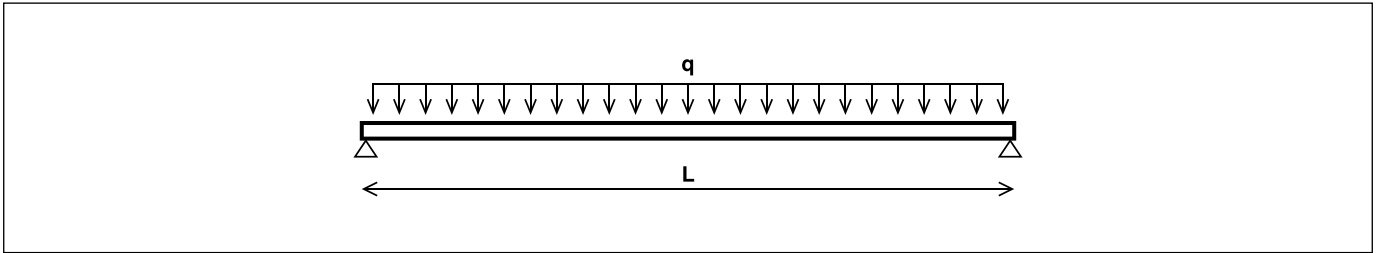

Steel sheet thickness: $t=0,75\text{mm}$

Fire resistance: 30 minutes

Plate thickness	Span L (m)														
h (m)	1,00	1,25	1,50	1,75	2,00	2,25	2,50	2,75	3,00	3,25	3,50	3,75	4,00	4,25	4,50
0,13	26,62	16,46	10,78	7,33	5,09	3,55	2,44	1,62	0,99	0,50	0,11				
0,14	28,32	18,14	11,88	8,10	5,63	3,93	2,71	1,81	1,12	0,58	0,15				
0,15	29,96	19,82	12,99	8,86	6,17	4,31	2,98	1,99	1,24	0,65	0,18				
0,16	31,55	21,51	14,10	9,62	6,70	4,69	3,25	2,18	1,36	0,72	0,22				
0,17	33,09	23,19	15,21	10,38	7,24	5,07	3,52	2,37	1,49	0,80	0,25				
0,18	34,59	24,87	16,32	11,15	7,78	5,46	3,79	2,55	1,61	0,87	0,28				

Steel sheet thickness: $t=1,00\text{mm}$

Fire resistance: 30 minutes

Plate thickness	Span L (m)														
h (m)	1,00	1,25	1,50	1,75	2,00	2,25	2,50	2,75	3,00	3,25	3,50	3,75	4,00	4,25	4,50
0,13	29,46	22,46	14,92	10,36	7,39	5,34	3,88	2,79	1,97	1,32	0,80	0,39			
0,14	31,36	24,53	16,45	11,43	8,16	5,92	4,30	3,11	2,20	1,48	0,92	0,46			
0,15	33,18	25,95	17,99	12,51	8,94	6,49	4,73	3,42	2,42	1,65	1,03	0,53			
0,16	34,95	27,32	19,52	13,58	9,71	7,06	5,15	3,73	2,65	1,81	1,14	0,60			
0,17	36,68	28,65	21,06	14,66	10,49	7,63	5,57	4,05	2,88	1,98	1,25	0,67			
0,18	38,35	29,95	22,59	15,73	11,27	8,20	5,99	4,36	3,11	2,14	1,37	0,74			

Steel sheet thickness: $t=1,25\text{mm}$

Fire resistance: 30 minutes

Plate thickness	Span L (m)														
h (m)	1,00	1,25	1,50	1,75	2,00	2,25	2,50	2,75	3,00	3,25	3,50	3,75	4,00	4,25	4,50
0,13	31,85	24,95	19,05	13,37	9,67	7,13	5,31	3,96	2,93	2,13	1,49	0,98	0,55	0,20	
0,14	33,91	26,55	21,01	14,75	10,69	7,89	5,89	4,40	3,27	2,39	1,68	1,12	0,65	0,26	
0,15	35,89	28,10	22,90	16,14	11,70	8,65	6,46	4,84	3,61	2,64	1,87	1,25	0,75	0,32	
0,16	37,82	29,59	24,11	17,53	12,72	9,41	7,04	5,28	3,94	2,90	2,06	1,39	0,84	0,38	
0,17	39,69	31,04	25,28	18,92	13,73	10,17	7,61	5,72	4,28	3,15	2,26	1,53	0,94	0,44	
0,18	41,51	32,46	26,42	20,30	14,75	10,93	8,19	6,16	4,61	3,41	2,45	1,67	1,03	0,50	

1ø14 1ø12 1ø10 1ø8 1ø6 Without additional reinforcement.

Fire dimensional sizing boards Symdeck 50

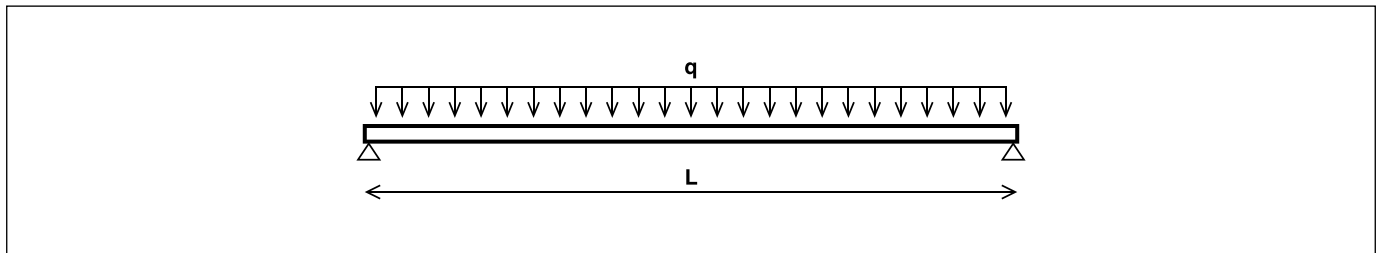

Steel sheet thickness: $t=0,75\text{mm}$

Fire resistance: 60 minutes

Plate thickness	Span L (m)														
h (m)	1,00	1,25	1,50	1,75	2,00	2,25	2,50	2,75	3,00	3,25	3,50	3,75	4,00	4,25	4,50
0,13	26,62	16,46	10,78	7,33	5,09	3,55	2,44	1,62	0,99	0,50	0,11				
0,14	28,32	18,14	11,88	8,10	5,63	3,93	2,71	1,81	1,12	0,58	0,15				
0,15	29,96	19,82	12,99	8,86	6,17	4,31	2,98	1,99	1,24	0,65	0,18				
0,16	31,55	21,51	14,10	9,62	6,70	4,69	3,25	2,18	1,36	0,72	0,22				
0,17	33,09	23,19	15,21	10,38	7,24	5,07	3,52	2,37	1,49	0,80	0,25				
0,18	34,59	24,87	16,32	11,15	7,78	5,46	3,79	2,55	1,61	0,87	0,28				

Steel sheet thickness: $t=1,00\text{mm}$

Fire resistance: 60 minutes

Plate thickness	Span L (m)														
h (m)	1,00	1,25	1,50	1,75	2,00	2,25	2,50	2,75	3,00	3,25	3,50	3,75	4,00	4,25	4,50
0,13	29,46	22,46	14,92	10,36	7,39	5,34	3,88	2,79	1,97	1,32	0,80	0,39			
0,14	31,36	24,53	16,45	11,43	8,16	5,92	4,30	3,11	2,20	1,48	0,92	0,46			
0,15	33,18	25,95	17,99	12,51	8,94	6,49	4,73	3,42	2,42	1,65	1,03	0,53			
0,16	34,95	27,32	19,52	13,58	9,71	7,06	5,15	3,73	2,65	1,81	1,14	0,60			
0,17	36,68	28,65	21,06	14,66	10,49	7,63	5,57	4,05	2,88	1,98	1,25	0,67			
0,18	38,35	29,95	22,59	15,73	11,27	8,20	5,99	4,36	3,11	2,14	1,37	0,74			

Steel sheet thickness: $t=1,25\text{mm}$

Fire resistance: 60 minutes

Plate thickness	Span L (m)														
h (m)	1,00	1,25	1,50	1,75	2,00	2,25	2,50	2,75	3,00	3,25	3,50	3,75	4,00	4,25	4,50
0,13	31,85	24,95	19,05	13,37	9,67	7,13	5,31	3,96	2,93	2,13	1,49	0,98	0,55	0,20	
0,14	33,91	26,55	21,01	14,75	10,69	7,89	5,89	4,40	3,27	2,39	1,68	1,12	0,65	0,26	
0,15	35,89	28,10	22,90	16,14	11,70	8,65	6,46	4,84	3,61	2,64	1,87	1,25	0,75	0,32	
0,16	37,82	29,59	24,11	17,53	12,72	9,41	7,04	5,28	3,94	2,90	2,06	1,39	0,84	0,38	
0,17	39,69	31,04	25,28	18,92	13,73	10,17	7,61	5,72	4,28	3,15	2,26	1,53	0,94	0,44	
0,18	41,51	32,46	26,42	20,30	14,75	10,93	8,19	6,16	4,61	3,41	2,45	1,67	1,03	0,50	

Without additional reinforcement.
 1ø6
 1ø8
 1ø10
 1ø12
 1ø14

Fire dimensional sizing boards Symdeck 50

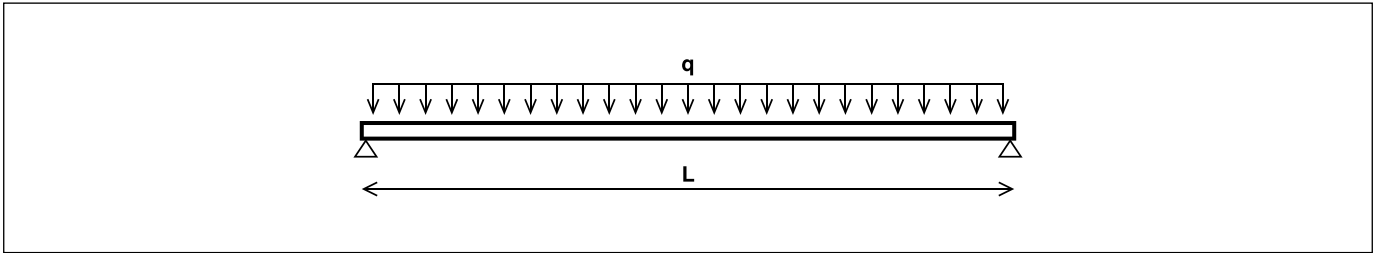

Steel sheet thickness: $t=0,75\text{mm}$

Fire resistance: 90 minutes

Plate thickness	Span L (m)														
h (m)	1,00	1,25	1,50	1,75	2,00	2,25	2,50	2,75	3,00	3,25	3,50	3,75	4,00	4,25	4,50
0,13	26,62	16,46	10,78	7,33	5,09	3,55	2,44	1,62	0,99	0,50	0,11				
0,14	28,32	18,14	11,88	8,10	5,63	3,93	2,71	1,81	1,12	0,58	0,15				
0,15	29,96	19,82	12,99	8,86	6,17	4,31	2,98	1,99	1,24	0,65	0,18				
0,16	31,55	21,51	14,10	9,62	6,70	4,69	3,25	2,18	1,36	0,72	0,22				
0,17	33,09	23,19	15,21	10,38	7,24	5,07	3,52	2,37	1,49	0,80	0,25				
0,18	34,59	24,87	16,32	11,15	7,78	5,46	3,79	2,55	1,61	0,87	0,28				

Steel sheet thickness: $t=1,00\text{mm}$

Fire resistance: 90 minutes

Plate thickness	Span L (m)														
h (m)	1,00	1,25	1,50	1,75	2,00	2,25	2,50	2,75	3,00	3,25	3,50	3,75	4,00	4,25	4,50
0,13	29,46	22,46	14,92	10,36	7,39	5,34	3,88	2,79	1,97	1,32	0,80	0,39			
0,14	31,36	24,53	16,45	11,43	8,16	5,92	4,30	3,11	2,20	1,48	0,92	0,46			
0,15	33,18	25,95	17,99	12,51	8,94	6,49	4,73	3,42	2,42	1,65	1,03	0,53			
0,16	34,95	27,32	19,52	13,58	9,71	7,06	5,15	3,73	2,65	1,81	1,14	0,60			
0,17	36,68	28,65	21,06	14,66	10,49	7,63	5,57	4,05	2,88	1,98	1,25	0,67			
0,18	38,35	29,95	22,59	15,73	11,27	8,20	5,99	4,36	3,11	2,14	1,37	0,74			

Steel sheet thickness: $t=1,25\text{mm}$

Fire resistance: 90 minutes

Plate thickness	Span L (m)														
h (m)	1,00	1,25	1,50	1,75	2,00	2,25	2,50	2,75	3,00	3,25	3,50	3,75	4,00	4,25	4,50
0,13	31,85	24,95	19,05	13,37	9,67	7,13	5,31	3,96	2,93	2,13	1,49	0,98	0,55	0,20	
0,14	33,91	26,55	21,01	14,75	10,69	7,89	5,89	4,40	3,27	2,39	1,68	1,12	0,65	0,26	
0,15	35,89	28,10	22,90	16,14	11,70	8,65	6,46	4,84	3,61	2,64	1,87	1,25	0,75	0,32	
0,16	37,82	29,59	24,11	17,53	12,72	9,41	7,04	5,28	3,94	2,90	2,06	1,39	0,84	0,38	
0,17	39,69	31,04	25,28	18,92	13,73	10,17	7,61	5,72	4,28	3,15	2,26	1,53	0,94	0,44	
0,18	41,51	32,46	26,42	20,30	14,75	10,93	8,19	6,16	4,61	3,41	2,45	1,67	1,03	0,50	

1ø14 1ø12 1ø10 1ø8 1ø6 Without additional reinforcement.

Fire dimensional sizing boards Symdeck 50

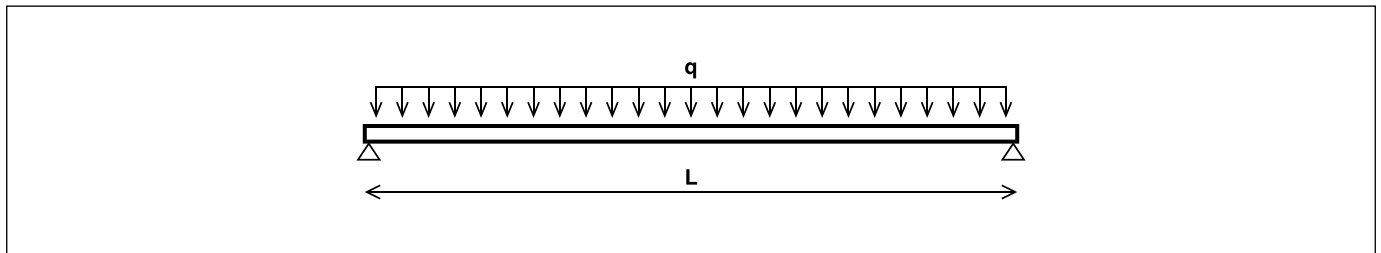

Steel sheet thickness: $t=0,75\text{mm}$

Fire resistance: 120 minutes

Plate thickness	Span L (m)														
h (m)	1,00	1,25	1,50	1,75	2,00	2,25	2,50	2,75	3,00	3,25	3,50	3,75	4,00	4,25	4,50
0,13	26,62	16,46	10,78	7,33	5,09	3,55	2,44	1,62	0,99	0,50	0,11				
0,14	28,32	18,14	11,88	8,10	5,63	3,93	2,71	1,81	1,12	0,58	0,15				
0,15	29,96	19,82	12,99	8,86	6,17	4,31	2,98	1,99	1,24	0,65	0,18				
0,16	31,55	21,51	14,10	9,62	6,70	4,69	3,25	2,18	1,36	0,72	0,22				
0,17	33,09	23,19	15,21	10,38	7,24	5,07	3,52	2,37	1,49	0,80	0,25				
0,18	34,59	24,87	16,32	11,15	7,78	5,46	3,79	2,55	1,61	0,87	0,28				

Steel sheet thickness: $t=1,00\text{mm}$

Fire resistance: 120 minutes

Plate thickness	Span L (m)														
h (m)	1,00	1,25	1,50	1,75	2,00	2,25	2,50	2,75	3,00	3,25	3,50	3,75	4,00	4,25	4,50
0,13	29,46	22,46	14,92	10,36	7,39	5,34	3,88	2,79	1,97	1,32	0,80	0,39			
0,14	31,36	24,53	16,45	11,43	8,16	5,92	4,30	3,11	2,20	1,48	0,92	0,46			
0,15	33,18	25,95	17,99	12,51	8,94	6,49	4,73	3,42	2,42	1,65	1,03	0,53			
0,16	34,95	27,32	19,52	13,58	9,71	7,06	5,15	3,73	2,65	1,81	1,14	0,60			
0,17	36,68	28,65	21,06	14,66	10,49	7,63	5,57	4,05	2,88	1,98	1,25	0,67			
0,18	38,35	29,95	22,59	15,73	11,27	8,20	5,99	4,36	3,11	2,14	1,37	0,74			

Steel sheet thickness: $t=1,25\text{mm}$

Fire resistance: 120 minutes

Plate thickness	Span L (m)														
h (m)	1,00	1,25	1,50	1,75	2,00	2,25	2,50	2,75	3,00	3,25	3,50	3,75	4,00	4,25	4,50
0,13	31,85	24,95	19,05	13,37	9,67	7,13	5,31	3,96	2,93	2,13	1,49	0,98	0,55	0,20	
0,14	33,91	26,55	21,01	14,75	10,69	7,89	5,89	4,40	3,27	2,39	1,68	1,12	0,65	0,26	
0,15	35,89	28,10	22,90	16,14	11,70	8,65	6,46	4,84	3,61	2,64	1,87	1,25	0,75	0,32	
0,16	37,82	29,59	24,11	17,53	12,72	9,41	7,04	5,28	3,94	2,90	2,06	1,39	0,84	0,38	
0,17	39,69	31,04	25,28	18,92	13,73	10,17	7,61	5,72	4,28	3,15	2,26	1,53	0,94	0,44	
0,18	41,51	32,46	26,42	20,30	14,75	10,93	8,19	6,16	4,61	3,41	2,45	1,67	1,03	0,50	

Without additional reinforcement.
 1ø6
 1ø8
 1ø10
 1ø12
 1ø14

Fire dimensional sizing boards Symdeck 50

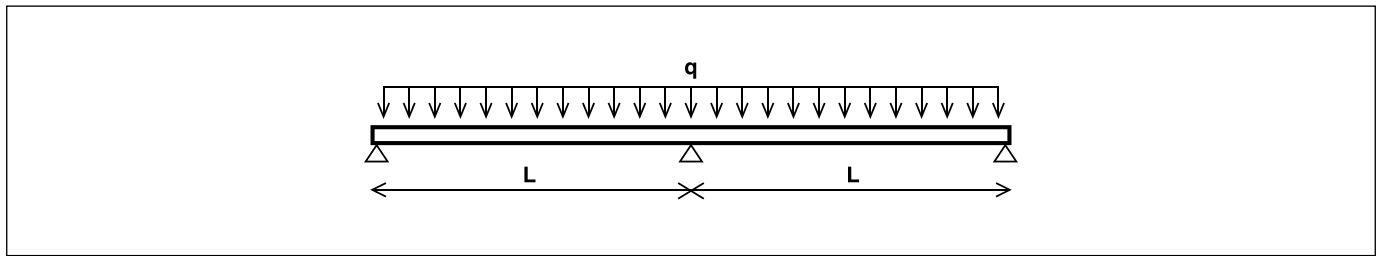

Reinforcement at the positions of bending moments						
h (m)	0,13	0,14	0,15	0,16	0,17	0,18
Diameter (mm) / Space (mm)	Ø8/200	Ø8/200	Ø8/150	Ø8/150	Ø10/200	Ø10/200

Steel sheet thickness: $t=0,75\text{mm}$

Fire resistance: 30 minutes

Plate thickness	Span L (m)														
h (m)	1,00	1,25	1,50	1,75	2,00	2,25	2,50	2,75	3,00	3,25	3,50	3,75	4,00	4,25	4,50
0,13	13,91	10,64	8,45	6,89	5,73	4,82	3,55	2,54	1,77	1,17	0,69				
0,14	15,27	11,68	9,28	7,57	6,29	5,29	3,93	2,82	1,97	1,31	0,78				
0,15	16,93	12,96	10,32	8,43	7,01	5,91	4,31	3,10	2,17	1,45	0,87				
0,16	18,37	14,07	11,20	9,15	7,62	6,42	4,69	3,38	2,37	1,59	0,96				
0,17	19,73	15,11	12,03	9,83	8,19	6,90	5,07	3,66	2,57	1,73	1,05				
0,18	21,18	16,23	12,92	10,57	8,80	7,42	5,46	3,93	2,77	1,87	1,15				

Steel sheet thickness: $t=1,00\text{mm}$

Fire resistance: 30 minutes

Plate thickness	Span L (m)														
h (m)	1,00	1,25	1,50	1,75	2,00	2,25	2,50	2,75	3,00	3,25	3,50	3,75	4,00	4,25	4,50
0,13	13,83	10,55	8,37	6,81	5,64	4,73	4,00	3,35	2,43	1,72	1,15	0,69	0,31		
0,14	15,18	11,59	9,20	7,49	6,21	5,21	4,41	3,72	2,71	1,92	1,30	0,79	0,37		
0,15	16,84	12,88	10,23	8,34	6,92	5,82	4,94	4,09	2,99	2,13	1,44	0,89	0,44		
0,16	18,28	13,98	11,11	9,07	7,53	6,34	5,38	4,46	3,26	2,33	1,59	0,99	0,50		
0,17	19,65	15,03	11,95	9,75	8,10	6,82	5,79	4,83	3,54	2,54	1,74	1,09	0,56		
0,18	21,09	16,14	12,84	10,48	8,71	7,34	6,24	5,20	3,82	2,74	1,89	1,19	0,62		

Steel sheet thickness: $t=1,25\text{mm}$

Fire resistance: 30 minutes

Plate thickness	Span L (m)														
h (m)	1,00	1,25	1,50	1,75	2,00	2,25	2,50	2,75	3,00	3,25	3,50	3,75	4,00	4,25	4,50
0,13	13,74	10,47	8,28	6,72	5,55	4,65	3,92	3,32	2,66	1,88	1,26	0,76	0,35	0,01	
0,14	15,09	11,50	9,11	7,40	6,12	5,12	4,32	3,67	3,08	2,20	1,51	0,94	0,48	0,10	
0,15	16,76	12,79	10,15	8,26	6,84	5,74	4,86	4,13	3,53	3,02	2,39	1,70	1,14	0,67	
0,16	18,19	13,89	11,03	8,98	7,44	6,25	5,29	4,51	3,86	3,31	2,63	1,88	1,27	0,76	
0,17	19,56	14,94	11,86	9,66	8,02	6,73	5,71	4,87	4,17	3,57	2,86	2,06	1,40	0,85	
0,18	21,01	16,06	12,75	10,39	8,63	7,25	6,15	5,25	4,50	3,86	3,09	2,23	1,53	0,94	

1ø14 1ø12 1ø10 1ø8 1ø6 Without additional reinforcement.

Fire dimensional sizing boards Symdeck 50

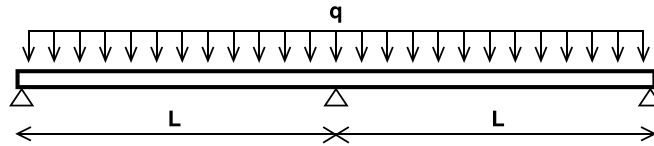

Reinforcement at the positions of bending moments

h (m)	0,13	0,14	0,15	0,16	0,17	0,18
Diameter (mm) / Space (mm)	Ø8/200	Ø8/200	Ø8/150	Ø8/150	Ø10/200	Ø10/200

Steel sheet thickness: $t=0,75\text{mm}$

Fire resistance: 60 minutes

Plate thickness	Span L (m)														
h (m)	1,00	1,25	1,50	1,75	2,00	2,25	2,50	2,75	3,00	3,25	3,50	3,75	4,00	4,25	4,50
0,13	13,91	10,64	8,45	6,89	5,73	4,82	3,55	2,54	1,77	1,17	0,69				
0,14	15,27	11,68	9,28	7,57	6,29	5,29	3,93	2,82	1,97	1,31	0,78				
0,15	16,93	12,96	10,32	8,43	7,01	5,91	4,31	3,10	2,17	1,45	0,87				
0,16	18,37	14,07	11,20	9,15	7,62	6,42	4,69	3,38	2,37	1,59	0,96				
0,17	19,73	15,11	12,03	9,83	8,19	6,90	5,07	3,66	2,57	1,73	1,05				
0,18	21,18	16,23	12,92	10,57	8,80	7,42	5,46	3,93	2,77	1,87	1,15				

Steel sheet thickness: $t=1,00\text{mm}$

Fire resistance: 60 minutes

Plate thickness	Span L (m)														
h (m)	1,00	1,25	1,50	1,75	2,00	2,25	2,50	2,75	3,00	3,25	3,50	3,75	4,00	4,25	4,50
0,13	13,83	10,55	8,37	6,81	5,64	4,73	4,00	3,35	2,43	1,72	1,15	0,69	0,31		
0,14	15,18	11,59	9,20	7,49	6,21	5,21	4,41	3,72	2,71	1,92	1,30	0,79	0,37		
0,15	16,84	12,88	10,23	8,34	6,92	5,82	4,94	4,09	2,99	2,13	1,44	0,89	0,44		
0,16	18,28	13,98	11,11	9,07	7,53	6,34	5,38	4,46	3,26	2,33	1,59	0,99	0,50		
0,17	19,65	15,03	11,95	9,75	8,10	6,82	5,79	4,83	3,54	2,54	1,74	1,09	0,56		
0,18	21,09	16,14	12,84	10,48	8,71	7,34	6,24	5,20	3,82	2,74	1,89	1,19	0,62		

Steel sheet thickness: $t=1,25\text{mm}$

Fire resistance: 60 minutes

Plate thickness	Span L (m)														
h (m)	1,00	1,25	1,50	1,75	2,00	2,25	2,50	2,75	3,00	3,25	3,50	3,75	4,00	4,25	4,50
0,13	13,74	10,47	8,28	6,72	5,55	4,65	3,92	3,32	2,66	1,88	1,26	0,76	0,35	0,01	
0,14	15,09	11,50	9,11	7,40	6,12	5,12	4,32	3,67	3,08	2,20	1,51	0,94	0,48	0,10	
0,15	16,76	12,79	10,15	8,26	6,84	5,74	4,86	4,13	3,53	3,02	2,39	1,70	1,14	0,67	
0,16	18,19	13,89	11,03	8,98	7,44	6,25	5,29	4,51	3,86	3,31	2,63	1,88	1,27	0,76	
0,17	19,56	14,94	11,86	9,66	8,02	6,73	5,71	4,87	4,17	3,57	2,86	2,06	1,40	0,85	
0,18	21,01	16,06	12,75	10,39	8,63	7,25	6,15	5,25	4,50	3,86	3,09	2,23	1,53	0,94	

□ Without additional reinforcement. □ 1ø6 □ 1ø8 □ 1ø10 □ 1ø12 □ 1ø14

Fire dimensional sizing boards Symdeck 50

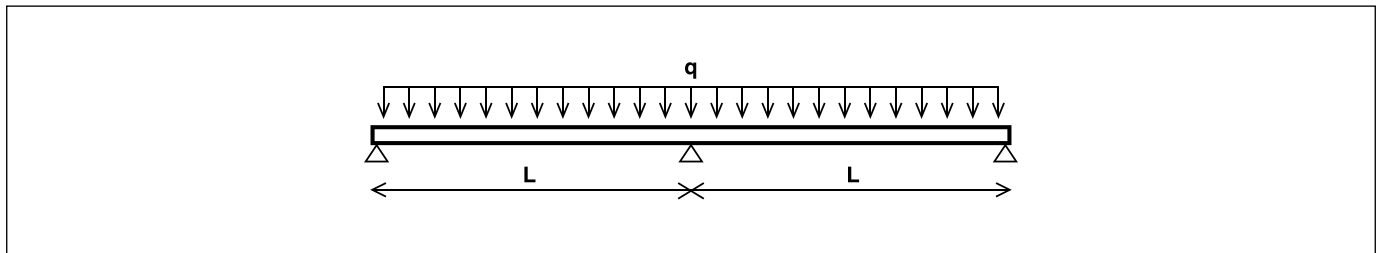

Reinforcement at the positions of bending moments						
h (m)	0,13	0,14	0,15	0,16	0,17	0,18
Diameter (mm) / Space (mm)	Ø8/200	Ø8/200	Ø8/150	Ø8/150	Ø10/200	Ø10/200

Steel sheet thickness: $t=0,75\text{mm}$

Fire resistance: 90 minutes

Plate thickness	Span L (m)														
h (m)	1,00	1,25	1,50	1,75	2,00	2,25	2,50	2,75	3,00	3,25	3,50	3,75	4,00	4,25	4,50
0,13	13,91	10,64	8,45	6,89	5,73	4,82	3,55	2,54	1,77	1,17	0,69				
0,14	15,27	11,68	9,28	7,57	6,29	5,29	3,93	2,82	1,97	1,31	0,78				
0,15	16,93	12,96	10,32	8,43	7,01	5,91	4,31	3,10	2,17	1,45	0,87				
0,16	18,37	14,07	11,20	9,15	7,62	6,42	4,69	3,38	2,37	1,59	0,96				
0,17	19,73	15,11	12,03	9,83	8,19	6,90	5,07	3,66	2,57	1,73	1,05				
0,18	21,18	16,23	12,92	10,57	8,80	7,42	5,46	3,93	2,77	1,87	1,15				

Steel sheet thickness: $t=1,00\text{mm}$

Fire resistance: 90 minutes

Plate thickness	Span L (m)														
h (m)	1,00	1,25	1,50	1,75	2,00	2,25	2,50	2,75	3,00	3,25	3,50	3,75	4,00	4,25	4,50
0,13	13,83	10,55	8,37	6,81	5,64	4,73	4,00	3,35	2,43	1,72	1,15	0,69	0,31		
0,14	15,18	11,59	9,20	7,49	6,21	5,21	4,41	3,72	2,71	1,92	1,30	0,79	0,37		
0,15	16,84	12,88	10,23	8,34	6,92	5,82	4,94	4,09	2,99	2,13	1,44	0,89	0,44		
0,16	18,28	13,98	11,11	9,07	7,53	6,34	5,38	4,46	3,26	2,33	1,59	0,99	0,50		
0,17	19,65	15,03	11,95	9,75	8,10	6,82	5,79	4,83	3,54	2,54	1,74	1,09	0,56		
0,18	21,09	16,14	12,84	10,48	8,71	7,34	6,24	5,20	3,82	2,74	1,89	1,19	0,62		

Steel sheet thickness: $t=1,25\text{mm}$

Fire resistance: 90 minutes

Plate thickness	Span L (m)														
h (m)	1,00	1,25	1,50	1,75	2,00	2,25	2,50	2,75	3,00	3,25	3,50	3,75	4,00	4,25	4,50
0,13	13,74	10,47	8,28	6,72	5,55	4,65	3,92	3,32	2,66	1,88	1,26	0,76	0,35	0,91	
0,14	15,09	11,50	9,11	7,40	6,12	5,12	4,32	3,67	3,08	2,20	1,51	0,94	0,48	0,10	
0,15	16,76	12,79	10,15	8,26	6,84	5,74	4,86	4,13	3,53	3,02	2,39	1,70	1,14	0,67	
0,16	18,19	13,89	11,03	8,98	7,44	6,25	5,29	4,51	3,86	3,31	2,63	1,88	1,27	0,76	
0,17	19,56	14,94	11,86	9,66	8,02	6,73	5,71	4,87	4,17	3,57	2,86	2,06	1,40	0,85	
0,18	21,01	16,06	12,75	10,39	8,63	7,25	6,15	5,25	4,50	3,86	3,09	2,23	1,53	0,94	

Fire dimensional sizing boards Symdeck 50

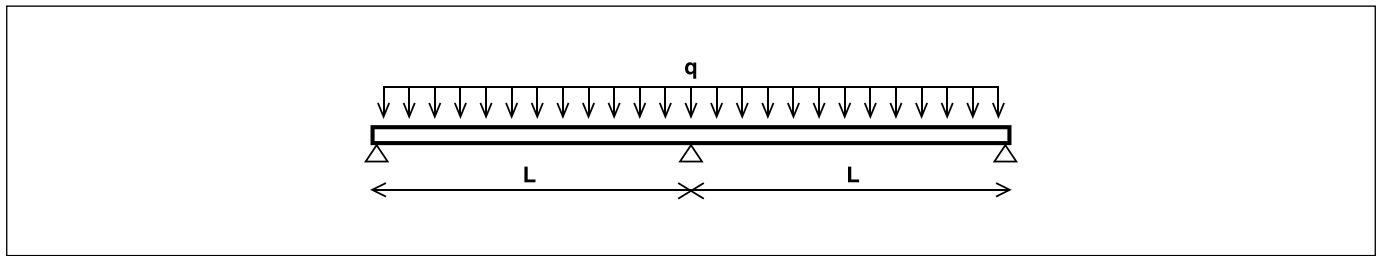

Reinforcement at the positions of bending moments						
h (m)	0,13	0,14	0,15	0,16	0,17	0,18
Diameter (mm) / Space (mm)	Ø8/200	Ø8/200	Ø8/150	Ø8/150	Ø10/200	Ø10/200

Steel sheet thickness: $t=0,75\text{mm}$

Fire resistance: 120 minutes

Plate thickness	Span L (m)														
h (m)	1,00	1,25	1,50	1,75	2,00	2,25	2,50	2,75	3,00	3,25	3,50	3,75	4,00	4,25	4,50
0,13	13,91	10,64	8,45	6,89	5,73	4,82	3,55	2,54	1,77	1,17	0,69				
0,14	15,27	11,68	9,28	7,57	6,29	5,29	3,93	2,82	1,97	1,31	0,78				
0,15	16,93	12,96	10,32	8,43	7,01	5,91	4,31	3,10	2,17	1,45	0,87				
0,16	18,37	14,07	11,20	9,15	7,62	6,42	4,69	3,38	2,37	1,59	0,96				
0,17	19,73	15,11	12,03	9,83	8,19	6,90	5,07	3,66	2,57	1,73	1,05				
0,18	21,18	16,23	12,92	10,57	8,80	7,42	5,46	3,93	2,77	1,87	1,15				

Steel sheet thickness: $t=1,00\text{mm}$

Fire resistance: 120 minutes

Plate thickness	Span L (m)														
h (m)	1,00	1,25	1,50	1,75	2,00	2,25	2,50	2,75	3,00	3,25	3,50	3,75	4,00	4,25	4,50
0,13	13,83	10,55	8,37	6,81	5,64	4,73	4,90	3,35	2,43	1,72	1,15	0,69	0,31		
0,14	15,18	11,59	9,20	7,49	6,21	5,21	4,41	3,72	2,71	1,92	1,30	0,79	0,37		
0,15	16,84	12,88	10,23	8,34	6,92	5,82	4,94	4,09	2,99	2,13	1,44	0,89	0,44		
0,16	18,28	13,98	11,11	9,07	7,53	6,34	5,38	4,46	3,26	2,33	1,59	0,99	0,50		
0,17	19,65	15,03	11,95	9,75	8,10	6,82	5,79	4,83	3,54	2,54	1,74	1,09	0,56		
0,18	21,09	16,14	12,84	10,48	8,71	7,34	6,24	5,20	3,82	2,74	1,89	1,19	0,62		

Steel sheet thickness: $t=1,25\text{mm}$

Fire resistance: 120 minutes

Plate thickness	Span L (m)														
h (m)	1,00	1,25	1,50	1,75	2,00	2,25	2,50	2,75	3,00	3,25	3,50	3,75	4,00	4,25	4,50
0,13	13,74	10,47	8,28	6,72	5,55	4,65	3,92	3,32	2,66	1,88	1,26	0,76	0,35	0,91	
0,14	15,09	11,50	9,11	7,40	6,12	5,12	4,32	3,67	3,08	2,20	1,51	0,94	0,48	0,10	
0,15	16,76	12,79	10,15	8,26	6,84	5,74	4,86	4,13	3,53	3,02	2,39	1,70	1,14	0,67	
0,16	18,19	13,89	11,03	8,98	7,44	6,25	5,29	4,51	3,86	3,31	2,63	1,88	1,27	0,76	
0,17	19,56	14,94	11,86	9,66	8,02	6,73	5,71	4,87	4,17	3,57	2,86	2,06	1,40	0,85	
0,18	21,01	16,06	12,75	10,39	8,63	7,25	6,15	5,25	4,50	3,86	3,09	2,23	1,53	0,94	

□ Without additional reinforcement. □ 1ø6 □ 1ø8 □ 1ø10 □ 1ø12 □ 1ø14

Fire dimensional sizing boards Symdeck 50

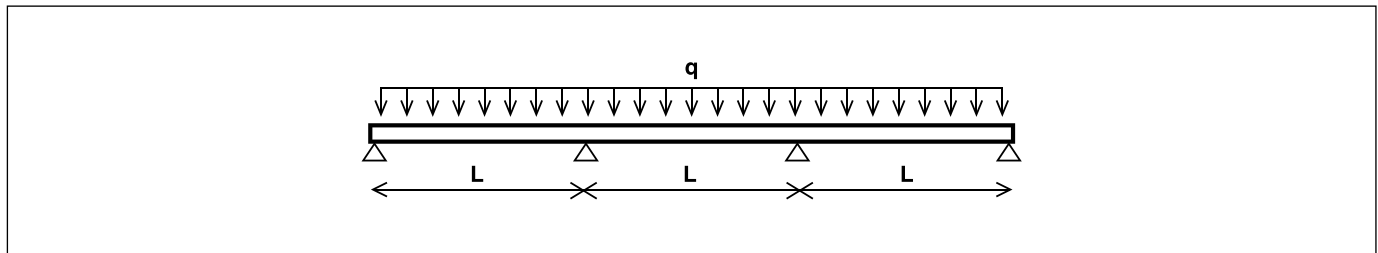

Reinforcement at the positions of bending moments

h (m)	0,13	0,14	0,15	0,16	0,17	0,18
Diameter (mm) / Space (mm)	Ø8/200	Ø8/200	Ø8/150	Ø8/150	Ø10/200	Ø10/200

Steel sheet thickness: t=0,75mm

Fire resistance: 30 minutes

Plate thickness	Span L (m)															
	h (m)	1,00	1,25	1,50	1,75	2,00	2,25	2,50	2,75	3,00	3,25	3,50	3,75	4,00	4,25	4,50
0,13	14,59	11,18	8,91	7,28	6,07	4,91	3,55	2,54	1,77	1,17	0,69					
0,14	16,01	12,27	9,78	8,00	6,66	5,43	3,93	2,82	1,97	1,31	0,78					
0,15	17,58	13,48	10,75	8,80	7,33	5,95	4,31	3,10	2,17	1,45	0,87					
0,16	19,09	14,65	11,68	9,57	7,98	6,47	4,69	3,38	2,37	1,59	0,96					
0,17	20,69	15,88	12,67	10,38	8,67	6,99	5,07	3,66	2,57	1,73	1,05					
0,18	22,21	17,05	13,61	11,15	9,31	7,50	5,46	3,93	2,77	1,87	1,15					

Steel sheet thickness: t=1,00mm

Fire resistance: 30 minutes

Plate thickness	Span L (m)															
	h (m)	1,00	1,25	1,50	1,75	2,00	2,25	2,50	2,75	3,00	3,25	3,50	3,75	4,00	4,25	4,50
0,13	14,51	11,10	8,82	7,20	5,98	5,03	4,28	3,35	2,43	1,72	1,15	0,69	0,31			
0,14	15,93	12,19	9,69	7,91	6,58	5,54	4,71	3,72	2,71	1,92	1,30	0,79	0,37			
0,15	17,49	13,40	10,66	8,71	7,25	6,11	5,20	4,09	2,99	2,13	1,44	0,89	0,44			
0,16	19,01	14,56	11,60	9,48	7,89	6,66	5,67	4,46	3,26	2,33	1,59	0,99	0,50			
0,17	20,61	15,80	12,59	10,30	8,58	7,24	6,18	4,83	3,54	2,54	1,74	1,09	0,56			
0,18	22,12	16,96	13,53	11,07	9,23	7,79	6,65	5,20	3,82	2,74	1,89	1,19	0,62			

Steel sheet thickness: t=1,25mm

Fire resistance: 30 minutes

Plate thickness	Span L (m)															
	h (m)	1,00	1,25	1,50	1,75	2,00	2,25	2,50	2,75	3,00	3,25	3,50	3,75	4,00	4,25	4,50
0,13	14,42	11,01	8,74	7,11	5,90	4,95	4,19	3,57	3,05	2,62	1,92	1,35	0,88	0,49		
0,14	15,84	12,10	9,61	7,83	6,49	5,45	4,62	3,94	3,38	2,90	2,16	1,53	1,01	0,58		
0,15	17,59	13,45	10,70	8,73	7,25	6,10	5,19	4,43	3,81	3,24	2,39	1,70	1,14	0,67		
0,16	19,09	14,61	11,62	9,49	7,89	6,65	5,65	4,84	4,16	3,55	2,63	1,88	1,27	0,76		
0,17	20,52	15,71	12,50	10,21	8,50	7,16	6,09	5,22	4,49	3,85	2,86	2,06	1,40	0,85		
0,18	22,04	16,88	13,44	10,98	9,14	7,71	6,56	5,62	4,84	4,16	3,09	2,23	1,53	0,94		

Fire dimensional sizing boards Symdeck 50

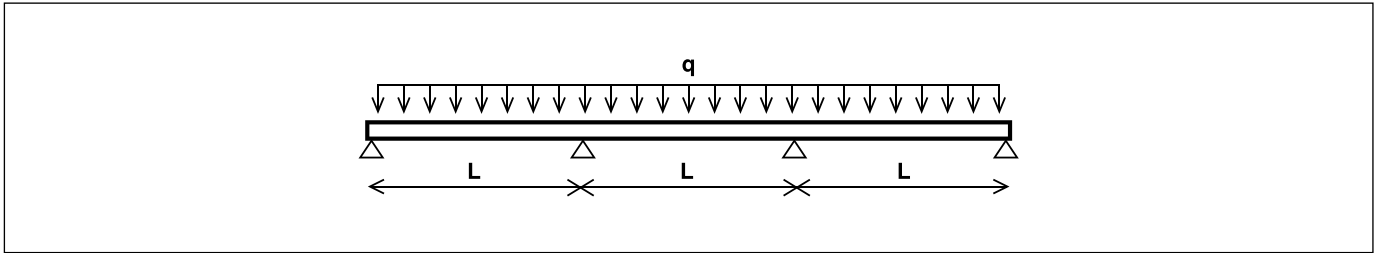

Reinforcement at the positions of bending moments						
h (m)	0,13	0,14	0,15	0,16	0,17	0,18
Diameter (mm) / Space (mm)	Ø8/200	Ø8/200	Ø8/150	Ø8/150	Ø10/200	Ø10/200

Steel sheet thickness: $t=0,75\text{mm}$

Fire resistance: 60 minutes

Plate thickness	Span L (m)															
	h (m)	1,00	1,25	1,50	1,75	2,00	2,25	2,50	2,75	3,00	3,25	3,50	3,75	4,00	4,25	4,50
0,13	14,59	11,18	8,91	7,28	6,07	4,91	3,55	2,54	1,77	1,17	0,69					
0,14	16,01	12,27	9,78	8,00	6,66	5,43	3,93	2,82	1,97	1,31	0,78					
0,15	17,58	13,48	10,75	8,80	7,33	5,95	4,31	3,10	2,17	1,45	0,87					
0,16	19,09	14,65	11,68	9,57	7,98	6,47	4,69	3,38	2,37	1,59	0,96					
0,17	20,69	15,88	12,67	10,38	8,67	6,99	5,07	3,66	2,57	1,73	1,05					
0,18	22,21	17,05	13,61	11,15	9,31	7,50	5,46	3,93	2,77	1,87	1,15					

Steel sheet thickness: $t=1,00\text{mm}$

Fire resistance: 60 minutes

Plate thickness	Span L (m)															
	h (m)	1,00	1,25	1,50	1,75	2,00	2,25	2,50	2,75	3,00	3,25	3,50	3,75	4,00	4,25	4,50
0,13	14,51	11,10	8,82	7,20	5,98	5,03	4,28	3,35	2,43	1,72	1,15	0,69	0,31			
0,14	15,93	12,19	9,69	7,91	6,58	5,54	4,71	3,72	2,71	1,92	1,30	0,79	0,37			
0,15	17,49	13,40	10,66	8,71	7,25	6,11	5,20	4,09	2,99	2,13	1,44	0,89	0,44			
0,16	19,01	14,56	11,60	9,48	7,89	6,66	5,67	4,46	3,26	2,33	1,59	0,99	0,50			
0,17	20,61	15,80	12,59	10,30	8,58	7,24	6,18	4,83	3,54	2,54	1,74	1,09	0,56			
0,18	22,12	16,96	13,53	11,07	9,23	7,79	6,65	5,20	3,82	2,74	1,89	1,19	0,62			

Steel sheet thickness: $t=1,25\text{mm}$

Fire resistance: 60 minutes

Plate thickness	Span L (m)															
	h (m)	1,00	1,25	1,50	1,75	2,00	2,25	2,50	2,75	3,00	3,25	3,50	3,75	4,00	4,25	4,50
0,13	14,42	11,01	8,74	7,11	5,90	4,95	4,19	3,57	3,05	2,62	1,92	1,35	0,88	0,49		
0,14	15,84	12,10	9,61	7,83	6,49	5,45	4,62	3,94	3,38	2,90	2,16	1,53	1,01	0,58		
0,15	17,59	13,45	10,70	8,73	7,25	6,10	5,19	4,43	3,81	3,24	2,39	1,70	1,14	0,67		
0,16	19,09	14,61	11,62	9,49	7,89	6,65	5,65	4,84	4,16	3,55	2,63	1,88	1,27	0,76		
0,17	20,52	15,71	12,50	10,21	8,50	7,16	6,09	5,22	4,49	3,85	2,86	2,06	1,40	0,85		
0,18	22,04	16,88	13,44	10,98	9,14	7,71	6,56	5,62	4,84	4,16	3,09	2,23	1,53	0,94		

Without additional reinforcement.
 1ø6
 1ø8
 1ø10
 1ø12
 1ø14

Fire dimensional sizing boards Symdeck 50

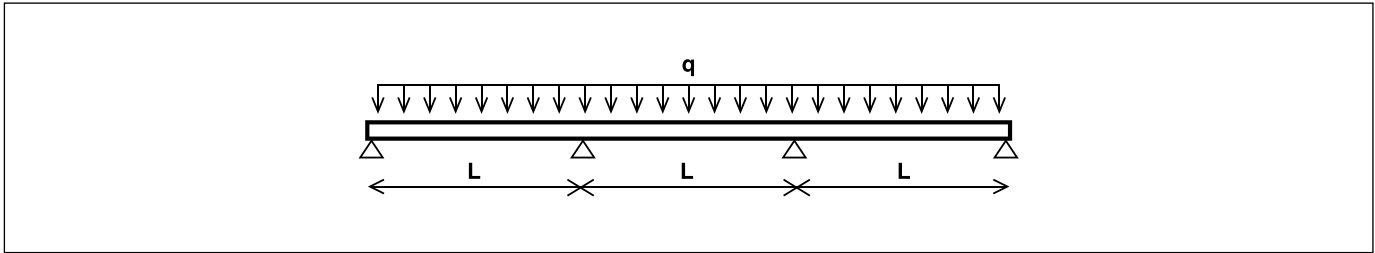

Reinforcement at the positions of bending moments

h (m)	0,13	0,14	0,15	0,16	0,17	0,18
Diameter (mm) / Space (mm)	Ø8/200	Ø8/200	Ø8/150	Ø8/150	Ø10/200	Ø10/200

Steel sheet thickness: t=0,75mm

Fire resistance: 90 minutes

Plate thickness	Span L (m)														
h (m)	1,00	1,25	1,50	1,75	2,00	2,25	2,50	2,75	3,00	3,25	3,50	3,75	4,00	4,25	4,50
0,13	14,59	11,18	8,91	7,28	6,07	4,91	3,55	2,54	1,77	1,17	0,69				
0,14	16,01	12,27	9,78	8,00	6,66	5,43	3,93	2,82	1,97	1,31	0,78				
0,15	17,58	13,48	10,75	8,80	7,33	5,95	4,31	3,10	2,17	1,45	0,87				
0,16	19,09	14,65	11,68	9,57	7,98	6,47	4,69	3,38	2,37	1,59	0,96				
0,17	20,69	15,88	12,67	10,38	8,67	6,99	5,07	3,66	2,57	1,73	1,05				
0,18	22,21	17,05	13,61	11,15	9,31	7,50	5,46	3,93	2,77	1,87	1,15				

Steel sheet thickness: t=1,00mm

Fire resistance: 90 minutes

Plate thickness	Span L (m)														
h (m)	1,00	1,25	1,50	1,75	2,00	2,25	2,50	2,75	3,00	3,25	3,50	3,75	4,00	4,25	4,50
0,13	14,51	11,10	8,82	7,20	5,98	5,03	4,28	3,35	2,43	1,72	1,15	0,69	0,31		
0,14	15,93	12,19	9,69	7,91	6,58	5,54	4,71	3,72	2,71	1,92	1,30	0,79	0,37		
0,15	17,49	13,40	10,66	8,71	7,25	6,11	5,20	4,09	2,99	2,13	1,44	0,89	0,44		
0,16	19,01	14,56	11,60	9,48	7,89	6,66	5,67	4,46	3,26	2,33	1,59	0,99	0,50		
0,17	20,61	15,80	12,59	10,30	8,58	7,24	6,18	4,83	3,54	2,54	1,74	1,09	0,56		
0,18	22,12	16,96	13,53	11,07	9,23	7,79	6,65	5,20	3,82	2,74	1,89	1,19	0,62		

Steel sheet thickness: t=1,25mm

Fire resistance: 90 minutes

Plate thickness	Span L (m)														
h (m)	1,00	1,25	1,50	1,75	2,00	2,25	2,50	2,75	3,00	3,25	3,50	3,75	4,00	4,25	4,50
0,13	14,42	11,01	8,74	7,11	5,90	4,95	4,19	3,57	3,05	2,62	1,92	1,35	0,88	0,49	
0,14	15,84	12,10	9,61	7,83	6,49	5,45	4,62	3,94	3,38	2,90	2,16	1,53	1,01	0,58	
0,15	17,59	13,45	10,70	8,73	7,25	6,10	5,19	4,43	3,81	3,24	2,39	1,70	1,14	0,67	
0,16	19,09	14,61	11,62	9,49	7,89	6,65	5,65	4,84	4,16	3,55	2,63	1,88	1,27	0,76	
0,17	20,52	15,71	12,50	10,21	8,50	7,16	6,09	5,22	4,49	3,85	2,86	2,06	1,40	0,85	
0,18	22,04	16,88	13,44	10,98	9,14	7,71	6,56	5,62	4,84	4,16	3,09	2,23	1,53	0,94	

Fire dimensional sizing boards Symdeck 50

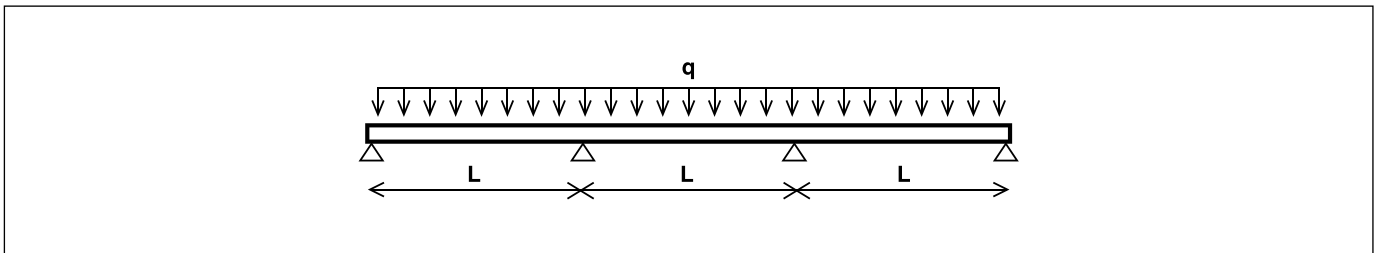

Reinforcement at the positions of bending moments						
h (m)	0,13	0,14	0,15	0,16	0,17	0,18
Diameter (mm) / Space (mm)	Ø8/200	Ø8/200	Ø8/150	Ø8/150	Ø10/200	Ø10/200

Steel sheet thickness: $t=0,75\text{mm}$

Fire resistance: 120 minutes

Plate thickness	Span L (m)															
	h (m)	1,00	1,25	1,50	1,75	2,00	2,25	2,50	2,75	3,00	3,25	3,50	3,75	4,00	4,25	4,50
0,13	14,59	11,18	8,91	7,28	6,07	4,91	3,55	2,54	1,77	1,17	0,69					
0,14	16,01	12,27	9,78	8,00	6,66	5,43	3,93	2,82	1,97	1,31	0,78					
0,15	17,58	13,48	10,75	8,80	7,33	5,95	4,31	3,10	2,17	1,45	0,87					
0,16	19,09	14,65	11,68	9,57	7,98	6,47	4,69	3,38	2,37	1,59	0,96					
0,17	20,69	15,88	12,67	10,38	8,67	6,99	5,07	3,66	2,57	1,73	1,05					
0,18	22,21	17,05	13,61	11,15	9,31	7,50	5,46	3,93	2,77	1,87	1,15					

Steel sheet thickness: $t=1,00\text{mm}$

Fire resistance: 120 minutes

Plate thickness	Span L (m)															
	h (m)	1,00	1,25	1,50	1,75	2,00	2,25	2,50	2,75	3,00	3,25	3,50	3,75	4,00	4,25	4,50
0,13	14,51	11,10	8,82	7,20	5,98	5,03	4,28	3,35	2,43	1,72	1,15	0,69	0,31			
0,14	15,93	12,19	9,69	7,91	6,58	5,54	4,71	3,72	2,71	1,92	1,30	0,79	0,37			
0,15	17,49	13,40	10,66	8,71	7,25	6,11	5,20	4,09	2,99	2,13	1,44	0,89	0,44			
0,16	19,01	14,56	11,60	9,48	7,89	6,66	5,67	4,46	3,26	2,33	1,59	0,99	0,50			
0,17	20,61	15,80	12,59	10,30	8,58	7,24	6,18	4,83	3,54	2,54	1,74	1,09	0,56			
0,18	22,12	16,96	13,53	11,07	9,23	7,79	6,65	5,20	3,82	2,74	1,89	1,19	0,62			

Steel sheet thickness: $t=1,25\text{mm}$

Fire resistance: 120 minutes

Plate thickness	Span L (m)															
	h (m)	1,00	1,25	1,50	1,75	2,00	2,25	2,50	2,75	3,00	3,25	3,50	3,75	4,00	4,25	4,50
0,13	14,42	11,01	8,74	7,11	5,90	4,95	4,19	3,57	3,05	2,62	1,92	1,35	0,88	0,49		
0,14	15,84	12,10	9,61	7,83	6,49	5,45	4,62	3,94	3,38	2,90	2,16	1,53	1,01	0,58		
0,15	17,59	13,45	10,70	8,73	7,25	6,10	5,19	4,43	3,81	3,24	2,39	1,70	1,14	0,67		
0,16	19,09	14,61	11,62	9,49	7,89	6,65	5,65	4,84	4,16	3,55	2,63	1,88	1,27	0,76		
0,17	20,52	15,71	12,50	10,21	8,50	7,16	6,09	5,22	4,49	3,85	2,86	2,06	1,40	0,85		
0,18	22,04	16,88	13,44	10,98	9,14	7,71	6,56	5,62	4,84	4,16	3,09	2,23	1,53	0,94		

Without additional reinforcement.
 1ø6
 1ø8
 1ø10
 1ø12
 1ø14

Fire dimensional sizing boards Symdeck 73

The following tables determine the maximum useful load Q that the composite plate can carry for three different static systems, for a range of openings from 1,00 m to 5,50 m, and for a coefficient value $\psi_2=0,60$. That is, the actual imperative useful load in the event of a fire, is the value given in the tables, multiplied by the factor $\psi_2=0,60$.

The tables are differentiated according to the fire resistance (the cases are R30, R60, R90, and R120).

For the design of more complex cases the relevant software is available on the website www.elastron.gr.

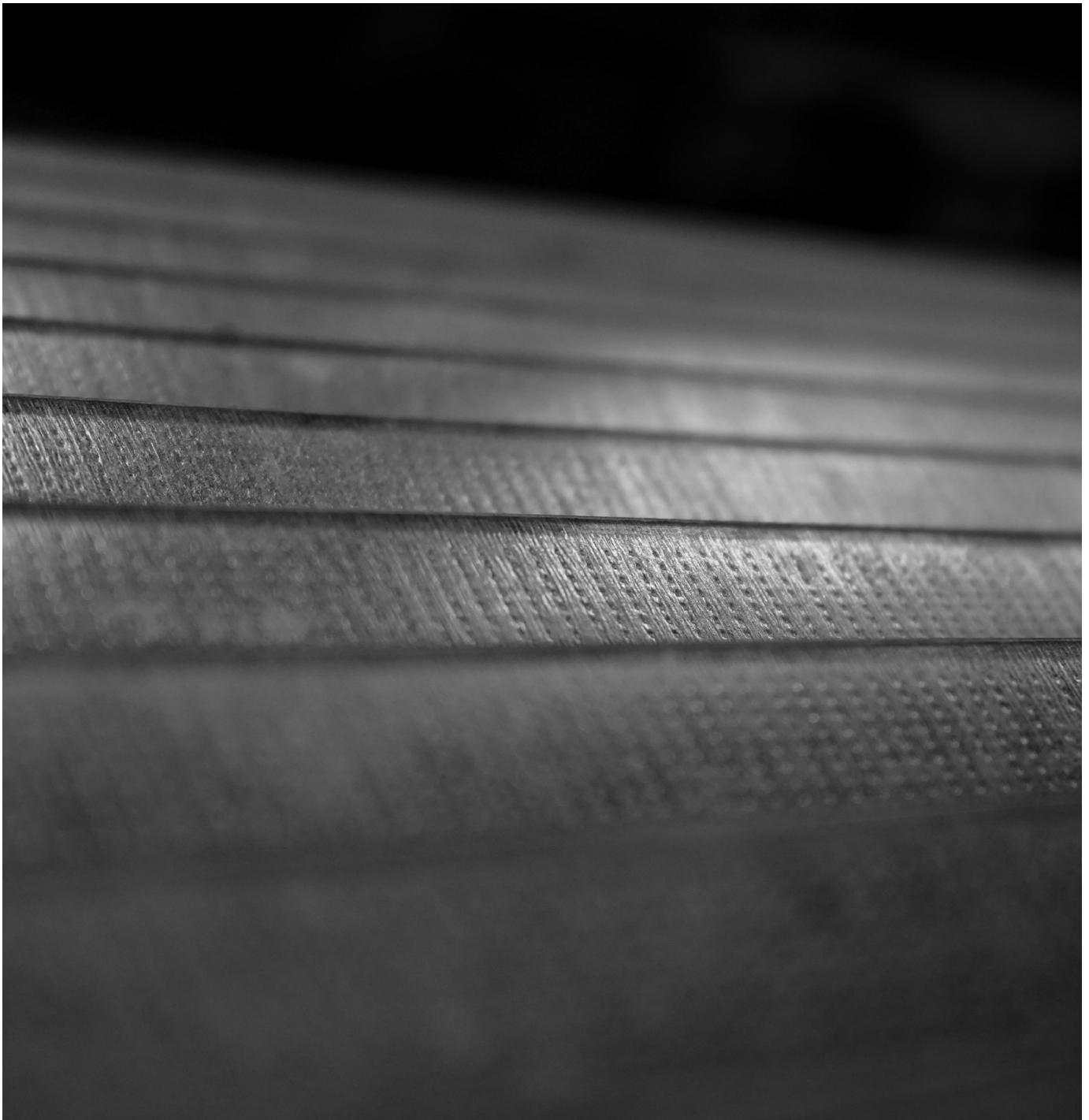

Fire dimensional sizing boards Symdeck 73

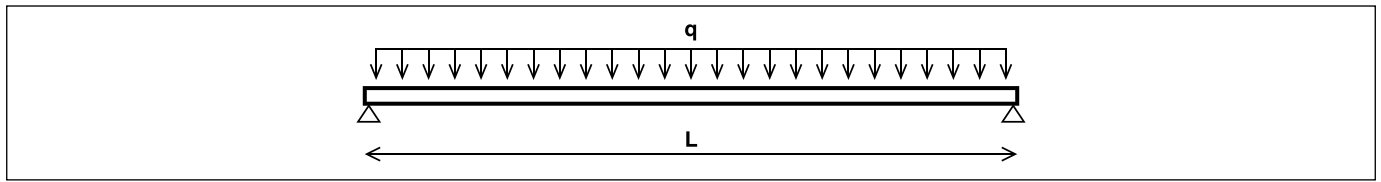

Steel sheet thickness: t=0,75mm, Concrete: C20/25, Steel reinforcement: B500C

Fire resistance: 30 minutes

Plate thickness	Span L (m)																		
h _i (m)	1,00	1,25	1,50	1,75	2,00	2,25	2,50	2,75	3,00	3,25	3,50	3,75	4,00	4,25	4,50	4,75	5,00	5,25	5,50
0,13	28,72	22,61	16,95	12,06	8,85	6,64	5,06	3,88	2,98	2,28	1,72	1,26	0,89	0,58					
0,14	30,83	24,21	18,92	13,44	9,87	7,40	5,64	4,32	3,32	2,54	1,91	1,41	0,99	0,65					
0,15	32,82	25,72	20,86	14,82	10,88	8,17	6,22	4,77	3,66	2,80	2,11	1,55	1,10	0,71					
0,16	34,72	27,22	22,12	16,02	11,89	8,93	6,80	5,21	4,00	3,06	2,31	1,70	1,20	0,78					
0,17	36,55	28,71	23,26	17,58	12,90	9,69	7,37	5,66	4,35	3,32	2,51	1,85	1,30	0,85					
0,18	38,40	30,09	24,44	18,96	13,92	10,45	7,95	6,10	4,69	3,58	2,70	1,99	1,41	0,92	0,51				
0,19	40,13	31,43	25,54	20,13	14,93	11,21	8,53	6,55	5,03	3,85	2,90	2,14	1,51	0,99	0,55				
0,20	41,89	32,65	26,72	21,67	15,94	11,97	9,11	6,99	5,37	4,11	3,10	2,28	1,61	1,06	0,59				

Maximum values of the variable load Q (kN/m²), ψ₂=0,60

Steel sheet thickness: t=0,80mm, Concrete: C20/25, Steel reinforcement: B500C

Fire resistance: 30 minutes

Plate thickness	Span L (m)																		
h _i (m)	1,00	1,25	1,50	1,75	2,00	2,25	2,50	2,75	3,00	3,25	3,50	3,75	4,00	4,25	4,50	4,75	5,00	5,25	5,50
0,13	29,25	23,00	17,87	12,84	9,45	7,11	5,44	4,19	3,24	2,50	1,91	1,43	1,03	0,71					
0,14	31,27	24,79	20,07	14,31	10,53	7,92	6,06	4,67	3,63	2,79	2,13	1,59	1,16	0,79					
0,15	33,55	26,15	21,55	15,78	11,61	8,74	6,68	5,15	3,98	3,07	2,35	1,76	1,28	0,87	0,54				
0,16	35,41	27,79	22,82	17,25	12,69	9,55	7,31	5,63	4,35	3,36	2,57	1,93	1,40	0,96	0,59				
0,17	37,23	29,11	2,96	18,52	13,77	10,37	7,93	6,11	4,73	3,65	2,79	2,09	1,52	1,04	0,64				
0,18	39,02	30,70	25,18	19,98	14,85	11,18	8,56	6,59	5,10	3,93	3,01	2,26	1,64	1,12	0,69				
0,19	40,79	32,06	26,08	21,56	15,94	12,00	9,18	7,07	5,47	4,22	3,23	2,42	1,76	1,21	0,74				
0,20	42,52	33,55	27,19	22,75	17,02	12,81	9,80	7,56	5,85	4,51	3,45	2,59	1,88	1,29	0,80				

Maximum values of the variable load Q (kN/m²), ψ₂=0,60

Steel sheet thickness: t=1,00mm, Concrete: C20/25, Steel reinforcement: B500C

Fire resistance: 30 minutes

Plate thickness	Span L (m)																		
h _i (m)	1,00	1,25	1,50	1,75	2,00	2,25	2,50	2,75	3,00	3,25	3,50	3,75	4,00	4,25	4,50	4,75	5,00	5,25	5,50
0,13	31,77	24,92	20,51	16,38	12,20	9,30	7,21	5,65	4,46	3,53	2,80	2,20	1,71	1,31	0,96	0,67			
0,14	33,98	26,89	22,01	18,17	13,60	10,37	8,03	6,30	4,97	3,94	3,12	2,46	1,91	1,46	1,08	0,75			
0,15	36,16	28,55	23,38	19,75	15,03	11,44	8,86	6,95	5,49	4,35	3,45	2,71	2,12	1,61	1,19	0,83	0,53		
0,16	38,19	29,98	24,73	20,70	16,32	12,50	9,68	7,60	6,00	4,76	3,77	2,97	2,32	1,76	1,31	0,92	0,58		
0,17	40,20	31,58	25,86	21,94	17,76	13,57	10,51	8,25	6,52	5,17	4,10	3,23	2,52	1,92	1,42	1,00	0,64		
0,18	42,38	33,46	27,28	22,86	19,04	14,63	11,34	8,90	7,03	5,58	4,42	3,48	2,72	2,07	1,54	1,08	0,69		
0,19	44,53	34,91	28,37	23,96	20,55	15,70	12,17	9,55	7,55	5,99	4,74	3,74	2,92	2,23	1,65	1,16	0,74		
0,20	46,45	36,44	29,74	24,95	21,32	16,73	13,00	10,20	8,06	6,39	5,07	4,00	3,12	2,38	1,77	1,24	0,80		

Maximum values of the variable load Q (kN/m²), ψ₂=0,60

Steel sheet thickness: t=1,25mm, Concrete: C20/25, Steel reinforcement: B500C

Fire resistance: 30 minutes

Plate thickness	Span L (m)																		
h _i (m)	1,00	1,25	1,50	1,75	2,00	2,25	2,50	2,75	3,00	3,25	3,50	3,75	4,00	4,25	4,50	4,75	5,00	5,25	5,50
0,13	34,31	27,05	22,20	18,72	15,44	11,94	9,34	7,41	5,94	4,79	3,87	3,13	2,53	2,03	1,60	1,24	0,94	0,67	
0,14	36,90	29,01	23,88	20,02	17,27	13,31	10,41	8,26	6,62	5,35	4,32	3,50	2,83	2,27	1,80	1,39	1,05	0,76	0,51
0,15	39,06	30,75	25,35	21,47	18,39	14,59	11,48	9,11	7,31	5,90	4,77	3,87	3,12	2,51	1,99	1,55	1,17	0,84	0,57
0,16	41,68	32,77	26,89	22,62	19,49	15,89	12,56	9,97	8,00	6,45	5,23	4,23	3,42	2,75	2,18	1,70	1,28	0,93	0,62
0,17	43,88	34,36	28,28	23,85	20,47	17,26	13,64	10,82	8,68	7,01	5,68	4,60	3,72	2,99	2,37	1,85	1,40	1,01	0,68
0,18	45,94	34,12	29,51	24,95	21,44	18,77	14,67	11,60	9,37	7,56	6,13	4,97	4,02	3,22	2,56	2,00	1,52	1,10	0,74
0,19	47,97	37,96	30,99	26,05	22,40	19,56	15,64	12,50	10,05	8,12	6,58	5,33	4,31	3,46	2,75	2,15	1,63	1,18	0,80
0,20	49,87	39,58	32,25	27,20	23,13	20,30	16,79	13,35	10,70	8,67	7,03	5,7	4,61	3,7	2,94	2,3	1,75	1,27	0,86

Maximum values of the variable load Q (kN/m²), ψ₂=0,60

□ Without additional reinforcement. □ 1ø6 □ 1ø8 □ 1ø10 □ 1ø12 □ 1ø14

Fire dimensional sizing boards Symdeck 73

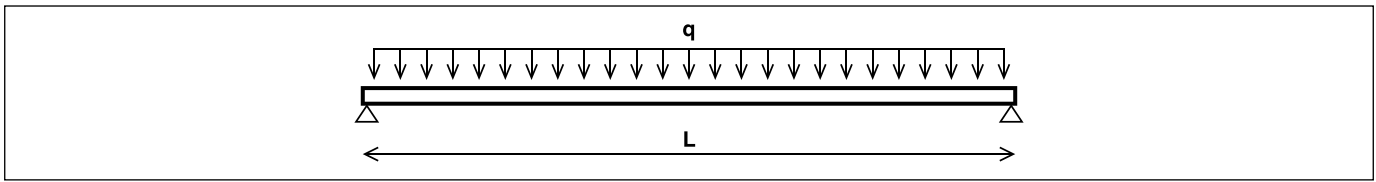

Steel sheet thickness: t=0,75mm, Concrete: C20/25, Steel reinforcement: B500C

Fire resistance: 60 minutes

Plate thickness	Span L (m)																		
h_i (m)	1,00	1,25	1,50	1,75	2,00	2,25	2,50	2,75	3,00	3,25	3,50	3,75	4,00	4,25	4,50	4,75	5,00	5,25	5,50
0,13	28,72	22,61	16,95	12,06	8,85	6,64	5,06	3,88	2,98	2,28	1,72	1,26	0,89	0,58					
0,14	30,83	2,21	18,92	13,44	9,87	7,40	5,64	4,32	3,32	2,54	1,91	1,41	0,99	0,65					
0,15	32,82	25,72	20,86	14,82	10,88	8,17	6,22	4,77	3,66	2,80	2,11	1,55	1,10	0,71					
0,16	34,72	27,22	22,12	16,02	11,89	8,93	6,80	5,21	4,00	3,06	2,31	1,70	1,20	0,78					
0,17	36,55	28,71	23,26	17,58	12,90	9,69	7,37	5,66	4,35	3,32	2,51	1,85	1,30	0,85					
0,18	38,40	30,09	24,44	18,96	13,92	10,45	7,95	6,10	4,69	3,58	2,70	1,99	1,41	0,92	0,51				
0,19	40,13	31,43	25,54	20,13	14,93	11,21	8,53	6,55	5,03	3,85	2,90	2,14	1,51	0,99	0,55				
0,20	41,89	32,65	26,72	21,67	15,94	11,97	9,11	6,99	5,37	4,11	3,10	2,28	1,61	1,06	0,59				

Maximum values of the variable load Q (kN/m²), $\psi_2=0,60$

Steel sheet thickness: t=0,80mm, Concrete: C20/25, Steel reinforcement: B500C

Fire resistance: 60 minutes

Plate thickness	Span L (m)																		
h_i (m)	1,00	1,25	1,50	1,75	2,00	2,25	2,50	2,75	3,00	3,25	3,50	3,75	4,00	4,25	4,50	4,75	5,00	5,25	5,50
0,13	29,25	23,00	17,87	12,84	9,45	7,11	5,44	4,19	3,24	2,50	1,91	1,43	1,03	0,71					
0,14	31,27	24,79	20,07	14,31	10,53	7,92	6,06	4,67	3,63	2,79	2,13	1,59	1,16	0,79					
0,15	33,55	26,15	21,55	15,78	11,61	8,74	6,68	5,15	3,98	3,07	2,35	1,76	1,28	0,87	0,54				
0,16	35,41	27,79	22,82	17,25	12,69	9,55	7,31	5,63	4,35	3,36	2,57	1,93	1,40	0,96	0,59				
0,17	37,23	29,11	23,96	18,52	13,77	10,37	7,93	6,11	4,73	3,65	2,79	2,09	1,52	1,04	0,64				
0,18	39,02	30,70	25,18	19,98	14,85	11,18	8,56	6,59	5,10	3,93	3,01	2,26	1,64	1,12	0,69				
0,19	40,79	32,06	26,08	21,56	15,94	12,00	9,18	7,07	5,47	4,22	3,23	2,42	1,76	1,21	0,74				
0,20	42,52	33,55	27,19	22,75	17,02	12,81	9,80	7,56	5,85	4,51	3,45	2,59	1,88	1,29	0,80				

Maximum values of the variable load Q (kN/m²), $\psi_2=0,60$

Steel sheet thickness: t=1,00mm, Concrete: C20/25, Steel reinforcement: B500C

Fire resistance: 60 minutes

Plate thickness	Span L (m)																		
h_i (m)	1,00	1,25	1,50	1,75	2,00	2,25	2,50	2,75	3,00	3,25	3,50	3,75	4,00	4,25	4,50	4,75	5,00	5,25	5,50
0,13	31,77	24,92	20,51	16,38	12,20	9,30	7,21	5,65	4,46	3,53	2,80	2,20	1,71	1,31	0,96	0,67			
0,14	33,98	26,89	22,01	18,17	13,6	10,37	8,03	6,30	4,97	3,94	3,12	2,46	1,91	1,46	1,08	0,75			
0,15	36,16	28,55	23,38	19,75	15,03	11,44	8,86	6,95	5,49	4,35	3,45	2,71	2,12	1,61	1,19	0,83	0,53		
0,16	38,19	29,98	24,73	20,70	16,32	12,5	9,68	7,60	6,00	4,76	3,77	2,97	2,32	1,76	1,31	0,92	0,58		
0,17	40,20	31,58	25,86	21,94	17,76	13,57	10,51	8,25	6,52	5,17	4,10	3,23	2,52	1,92	1,42	1,00	0,64		
0,18	42,38	33,46	27,28	22,86	19,04	14,63	11,34	8,90	7,03	5,58	4,42	3,48	2,72	2,07	1,54	1,08	0,69		
0,19	44,53	34,91	28,37	23,96	20,55	15,7	12,17	9,55	7,55	5,99	4,74	3,74	2,92	2,23	1,65	1,16	0,74		
0,20	46,45	36,44	29,74	24,95	21,32	16,73	13,00	10,20	8,06	6,39	5,07	4,00	3,12	2,38	1,77	1,24	0,80		

Maximum values of the variable load Q (kN/m²), $\psi_2=0,60$

Steel sheet thickness: t=1,25mm, Concrete: C20/25, Steel reinforcement: B500C

Fire resistance: 60 minutes

Plate thickness	Span L (m)																		
h_i (m)	1,00	1,25	1,50	1,75	2,00	2,25	2,50	2,75	3,00	3,25	3,50	3,75	4,00	4,25	4,50	4,75	5,00	5,25	5,50
0,13	34,31	27,05	22,20	18,72	15,44	11,94	9,34	7,41	5,94	4,79	3,87	3,13	2,53	2,03	1,60	1,24	0,94	0,67	
0,14	36,90	29,01	23,88	20,02	17,27	13,31	10,41	8,26	6,62	5,35	4,32	3,50	2,83	2,27	1,80	1,39	1,05	0,76	0,51
0,15	39,06	30,75	25,35	21,47	18,39	14,59	11,48	9,11	7,31	5,90	4,77	3,87	3,12	2,51	1,99	1,55	1,17	0,84	0,57
0,16	41,68	32,77	26,89	22,62	19,49	15,89	12,56	9,97	8,00	6,45	5,23	4,23	3,42	2,75	2,18	1,70	1,28	0,93	0,62
0,17	43,88	34,36	28,28	23,85	20,47	17,26	13,64	10,82	8,68	7,01	5,68	4,60	3,72	2,99	2,37	1,85	1,40	1,01	0,68
0,18	45,94	34,12	29,51	24,95	21,44	18,77	14,67	11,60	9,37	7,56	6,13	4,97	4,02	3,22	2,56	2,00	1,52	1,10	0,74
0,19	47,97	37,96	30,99	26,05	22,40	19,56	15,64	12,50	10,05	8,12	6,58	5,33	4,31	3,46	2,75	2,15	1,63	1,18	0,80
0,20	49,87	39,58	32,25	27,20	23,13	20,30	16,79	13,35	10,70	8,67	7,03	5,70	4,61	3,70	2,94	2,3	1,75	1,27	0,86

Maximum values of the variable load Q (kN/m²), $\psi_2=0,60$

1ø14 1ø12 1ø10 1ø8 1ø6 Without additional reinforcement.

Fire dimensional sizing boards Symdeck 73

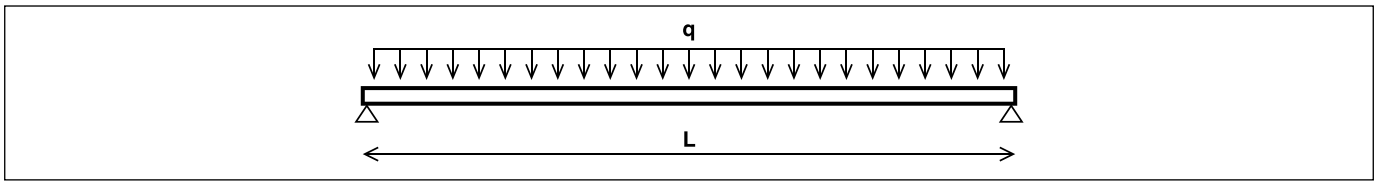

Steel sheet thickness: $t=0,75\text{mm}$, Concrete: C20/25, Steel reinforcement: B500C

Fire resistance: 90 minutes

Plate thickness	Span L (m)																		
h_i (m)	1,00	1,25	1,50	1,75	2,00	2,25	2,50	2,75	3,00	3,25	3,50	3,75	4,00	4,25	4,50	4,75	5,00	5,25	5,50
0,13	28,72	22,61	16,95	12,06	8,85	6,64	5,96	3,88	2,98	2,28	1,72	1,26	0,89	0,58					
0,14	30,83	24,21	18,92	13,44	9,87	7,40	5,64	4,32	3,32	2,54	1,91	1,41	0,99	0,65					
0,15	32,82	25,72	20,86	14,82	10,88	8,17	6,22	4,77	3,66	2,8	2,11	1,55	1,10	0,71					
0,16	34,72	27,22	22,12	16,02	11,89	8,93	6,80	5,21	4,00	3,06	2,31	1,70	1,20	0,78					
0,17	36,55	28,71	23,26	17,58	12,90	9,69	7,37	5,66	4,35	3,32	2,51	1,85	1,30	0,85					
0,18	38,40	30,09	24,44	18,96	13,92	10,45	7,95	6,10	4,69	3,58	2,70	1,99	1,41	0,92	0,51				
0,19	40,13	31,43	25,54	20,13	14,93	11,21	8,53	6,55	5,03	3,85	2,90	2,14	1,51	0,99	0,55				
0,20	41,89	32,65	26,72	21,67	15,94	11,97	9,11	6,99	5,37	4,11	3,10	2,28	1,61	1,06	0,59				

Maximum values of the variable load Q (kN/m²), $\psi_2=0,60$

Steel sheet thickness: $t=0,80\text{mm}$, Concrete: C20/25, Steel reinforcement: B500C

Fire resistance: 90 minutes

Plate thickness	Span L (m)																		
h_i (m)	1,00	1,25	1,50	1,75	2,00	2,25	2,50	2,75	3,00	3,25	3,50	3,75	4,00	4,25	4,50	4,75	5,00	5,25	5,50
0,13	29,25	23,90	17,87	12,84	9,45	7,11	5,44	4,19	3,24	2,50	1,91	1,43	1,03	0,71					
0,14	31,27	24,79	20,07	14,31	10,53	7,92	6,06	4,67	3,63	2,79	2,13	1,59	1,16	0,79					
0,15	33,55	26,15	21,55	15,78	11,61	8,74	6,68	5,15	3,98	3,07	2,35	1,76	1,28	0,87	0,54				
0,16	35,41	27,79	22,82	17,25	12,69	9,55	7,31	5,63	4,35	3,36	2,57	1,93	1,40	0,96	0,59				
0,17	37,23	29,11	23,96	18,52	13,77	10,37	7,93	6,11	4,73	3,65	2,79	2,09	1,52	1,04	0,64				
0,18	39,02	30,70	25,18	19,98	14,85	11,18	8,56	6,59	5,10	3,93	3,01	2,26	1,64	1,12	0,69				
0,19	40,79	32,06	26,08	21,56	15,94	12,00	9,18	7,07	5,47	4,22	3,23	2,42	1,76	1,21	0,74				
0,20	42,52	33,55	27,19	22,75	17,02	12,81	9,80	7,56	5,85	4,51	3,45	2,59	1,88	1,29	0,80				

Maximum values of the variable load Q (kN/m²), $\psi_2=0,60$

Steel sheet thickness: $t=1,00\text{mm}$, Concrete: C20/25, Steel reinforcement: B500C

Fire resistance: 90 minutes

Plate thickness	Span L (m)																		
h_i (m)	1,00	1,25	1,50	1,75	2,00	2,25	2,50	2,75	3,00	3,25	3,50	3,75	4,00	4,25	4,50	4,75	5,00	5,25	5,50
0,13	31,77	24,92	20,51	16,38	12,20	9,30	7,21	5,65	4,46	3,53	2,80	2,20	1,71	1,31	0,96	0,67			
0,14	33,98	26,89	22,01	18,17	13,60	10,37	8,03	6,30	4,97	3,94	3,12	2,46	1,91	1,46	1,08	0,75			
0,15	36,16	28,55	23,38	19,75	15,03	11,44	8,86	6,95	5,49	4,35	3,45	2,71	2,12	1,61	1,19	0,83	0,53		
0,16	38,19	29,98	24,73	20,70	16,32	12,50	9,68	7,60	6,00	4,76	3,77	2,97	2,32	1,76	1,31	0,92	0,58		
0,17	40,20	31,58	25,86	21,94	17,76	13,57	10,51	8,25	6,52	5,17	4,10	3,23	2,52	1,92	1,42	1,00	0,64		
0,18	42,38	33,46	27,28	22,86	19,04	14,63	11,34	8,90	7,03	5,58	4,42	3,48	2,72	2,07	1,54	1,08	0,69		
0,19	44,53	34,91	28,37	23,96	20,55	15,70	12,17	9,55	7,55	5,99	4,74	3,74	2,92	2,23	1,65	1,16	0,74		
0,20	46,45	36,44	29,74	24,95	21,32	16,73	13,00	10,20	8,06	6,39	5,07	4,00	3,12	2,38	1,77	1,24	0,80		

Maximum values of the variable load Q (kN/m²), $\psi_2=0,60$

Steel sheet thickness: $t=1,25\text{mm}$, Concrete: C20/25, Steel reinforcement: B500C

Fire resistance: 90 minutes

Plate thickness	Span L (m)																		
h_i (m)	1,00	1,25	1,50	1,75	2,00	2,25	2,50	2,75	3,00	3,25	3,50	3,75	4,00	4,25	4,50	4,75	5,00	5,25	5,50
0,13	34,31	27,95	22,20	18,72	15,44	11,94	9,34	7,41	5,94	4,79	3,87	3,13	2,53	2,03	1,60	1,24	0,94	0,67	
0,14	36,90	29,01	23,88	20,02	17,27	13,31	10,41	8,26	6,62	5,35	4,32	3,50	2,83	2,27	1,80	1,39	1,05	0,76	0,51
0,15	39,06	30,75	25,35	21,47	18,39	14,59	11,48	9,11	7,31	5,90	4,77	3,87	3,12	2,51	1,99	1,55	1,17	0,84	0,57
0,16	41,68	32,77	26,89	22,62	19,49	15,89	12,56	9,97	8,00	6,45	5,23	4,23	3,42	2,75	2,18	1,70	1,28	0,93	0,62
0,17	43,88	34,36	28,28	23,85	20,47	17,26	13,64	10,82	8,68	7,01	5,68	4,60	3,72	2,99	2,37	1,85	1,40	1,01	0,68
0,18	45,94	34,12	29,51	24,95	21,44	18,77	14,67	11,60	9,37	7,56	6,13	4,97	4,02	3,22	2,56	2,00	1,52	1,10	0,74
0,19	47,97	37,96	30,99	26,05	22,40	19,56	15,64	12,50	10,05	8,12	6,58	5,33	4,31	3,46	2,75	2,15	1,63	1,18	0,80
0,20	49,87	39,58	32,25	27,20	23,13	20,30	16,79	13,35	10,70	8,67	7,03	5,7	4,61	3,70	2,94	2,30	1,75	1,27	0,86

Maximum values of the variable load Q (kN/m²), $\psi_2=0,60$

Without additional reinforcement.
 1ø6
 1ø8
 1ø10
 1ø12
 1ø14

Fire dimensional sizing boards Symdeck 73

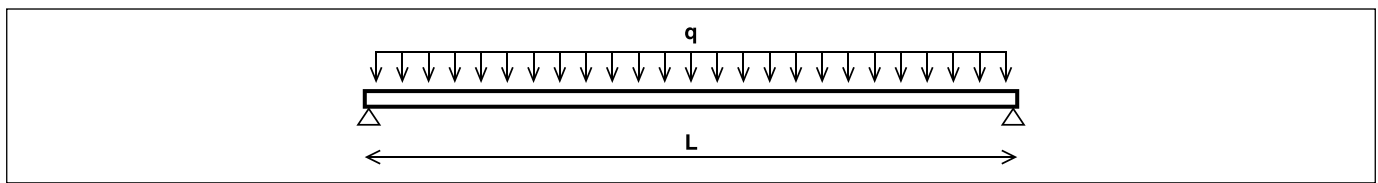

Steel sheet thickness: $t=0,75\text{mm}$, Concrete: C20/25, Steel reinforcement: B500C

Fire resistance: 120 minutes

Plate thickness	Span L (m)																		
h_i (m)	1,00	1,25	1,50	1,75	2,00	2,25	2,50	2,75	3,00	3,25	3,50	3,75	4,00	4,25	4,50	4,75	5,00	5,25	5,50
0,13	28,72	22,61	16,95	12,06	8,85	6,64	5,96	3,88	2,98	2,28	1,72	1,26	0,89	0,58					
0,14	30,83	24,21	18,92	13,44	9,87	7,40	5,64	4,32	3,32	2,45	1,55	0,82	0,23						
0,15	32,82	25,72	20,86	14,82	10,88	8,17	6,22	4,77	3,66	2,66	1,67	0,88	0,23						
0,16	34,72	27,22	22,12	16,02	11,89	8,93	6,80	5,21	4,90	2,87	1,80	0,93	0,22						
0,17	36,55	28,71	23,26	17,58	12,90	9,69	7,37	5,66	4,35	3,08	1,92	0,99	0,22						
0,18	38,40	30,09	24,44	18,96	13,92	10,45	7,95	6,10	4,69	3,29	2,04	1,04	0,22						
0,19	40,13	31,43	25,54	20,13	14,93	11,21	8,53	6,55	5,03	3,50	2,17	1,09	0,21						
0,20	41,89	32,65	26,72	21,67	15,94	11,97	9,11	6,99	5,37	3,71	2,29	1,15	0,21						

Maximum values of the variable load Q (kN/m²), $\psi_2=0,60$

Steel sheet thickness: $t=0,80\text{mm}$, Concrete: C20/25, Steel reinforcement: B500C

Fire resistance: 120 minutes

Plate thickness	Span L (m)																		
h_i (m)	1,00	1,25	1,50	1,75	2,00	2,25	2,50	2,75	3,00	3,25	3,50	3,75	4,00	4,25	4,50	4,75	5,00	5,25	5,50
0,13	29,25	23,90	17,87	12,84	9,45	7,11	5,44	4,19	3,24	2,5	1,91	1,43	1,03	0,71					
0,14	31,27	24,79	20,07	14,31	10,53	7,92	6,06	4,67	3,63	2,52	1,61	0,87	0,27						
0,15	33,55	26,15	21,55	15,78	11,61	8,74	6,68	5,15	3,98	2,74	1,74	0,93	0,27						
0,16	35,41	27,79	22,82	17,25	12,69	9,55	7,31	5,63	4,33	2,96	1,87	1,00	0,28						
0,17	37,23	29,11	23,96	18,52	13,77	10,37	7,93	6,11	4,66	3,18	2,01	1,06	0,28						
0,18	39,02	30,70	25,18	19,98	14,85	11,18	8,56	6,59	4,99	3,40	2,14	1,12	0,29						
0,19	40,79	32,06	26,08	21,56	15,94	12,00	9,18	7,07	5,32	3,62	2,27	1,18	0,29						
0,20	42,52	33,55	27,19	22,75	17,02	12,81	9,80	7,56	5,65	3,84	2,4	1,24	0,29						

Maximum values of the variable load Q (kN/m²), $\psi_2=0,60$

Steel sheet thickness: $t=1,00\text{mm}$, Concrete: C20/25, Steel reinforcement: B500C

Fire resistance: 120 minutes

Plate thickness	Span L (m)																		
h_i (m)	1,00	1,25	1,50	1,75	2,00	2,25	2,50	2,75	3,00	3,25	3,50	3,75	4,00	4,25	4,50	4,75	5,00	5,25	5,50
0,13	31,77	24,92	20,51	16,38	12,20	9,30	7,21	5,65	4,46	3,53	2,80	2,20	1,71	1,31	0,96	0,67			
0,14	33,98	26,89	22,01	18,17	13,60	10,37	7,80	5,73	4,15	2,93	1,96	1,17	0,53						
0,15	36,16	28,55	23,38	19,75	15,03	11,44	8,54	6,27	4,54	3,2	2,13	1,27	0,56						
0,16	38,19	29,98	24,73	20,70	16,32	12,50	9,28	6,81	4,93	3,47	2,30	1,37	0,60						
0,17	40,20	31,58	25,86	21,94	17,76	13,57	10,02	7,35	5,32	3,73	2,48	1,46	0,64						
0,18	42,38	33,46	27,28	22,86	19,04	14,63	10,77	7,89	5,70	4,00	2,65	1,56	0,67						
0,19	44,53	34,91	28,37	23,96	20,55	15,66	11,51	8,43	6,09	4,27	2,83	1,66	0,71						
0,20	46,45	36,44	29,74	24,95	21,32	16,68	12,25	8,97	6,48	4,54	3,00	1,76	0,74						

Maximum values of the variable load Q (kN/m²), $\psi_2=0,60$

Steel sheet thickness: $t=1,25\text{mm}$, Concrete: C20/25, Steel reinforcement: B500C

Fire resistance: 120 minutes

Plate thickness	Span L (m)																		
h_i (m)	1,00	1,25	1,50	1,75	2,00	2,25	2,50	2,75	3,00	3,25	3,50	3,75	4,00	4,25	4,50	4,75	5,00	5,25	5,50
0,13	34,31	27,95	22,20	18,72	15,44	11,94	9,34	7,41	5,94	4,79	3,87	3,13	2,53	2,03	1,60	1,24	0,94	0,67	
0,14	36,90	29,01	23,88	20,02	15,86	11,66	8,65	6,43	4,74	3,42	2,37	1,53	0,84	0,27					
0,15	39,06	30,75	25,35	21,47	17,41	12,79	9,49	7,95	5,19	3,74	2,60	1,67	0,91	0,29					
0,16	41,68	32,77	26,89	22,62	18,95	13,92	10,33	7,67	5,65	4,97	2,82	1,81	0,99	0,30					
0,17	43,88	34,36	28,28	23,85	20,47	15,06	11,17	8,29	6,10	4,40	3,04	1,95	1,06	0,32					
0,18	45,94	34,12	29,51	24,95	21,44	16,19	12,01	8,91	6,56	4,72	3,27	2,10	1,14	0,34					
0,19	47,97	37,96	30,99	26,05	22,40	17,32	12,84	9,53	7,01	5,05	3,49	2,24	1,21	0,36					
0,20	49,87	39,58	32,25	27,20	23,13	18,46	13,68	10,15	7,47	5,37	3,72	2,38	1,28	0,37					

Maximum values of the variable load Q (kN/m²), $\psi_2=0,60$

1ø14 1ø12 1ø10 1ø8 1ø6 Without additional reinforcement.

Fire dimensional sizing boards Symdeck 73

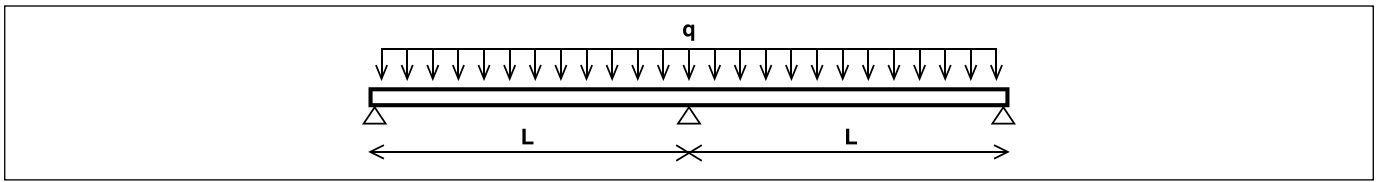

Reinforcement in positions of bending moments								
h_t (m)	0,13	0,14	0,15	0,16	0,17	0,18	0,19	0,20
Diameter (mm) / Space (mm)	Ø8/200	Ø8/200	Ø8/150	Ø8/150	Ø10/200	Ø10/200	Ø10/150	Ø10/150

Steel sheet thickness: $t=0,75\text{mm}$, Concrete: C20/25, Steel reinforcement: B500C

Fire resistance: 30 minutes

Plate thickness	Span L (m)																			
h_t (m)	1,00	1,25	1,50	1,75	2,00	2,25	2,50	2,75	3,00	3,25	3,50	3,75	4,00	4,25	4,50	4,75	5,00	5,25	5,50	
0,13	22,58	17,67	14,36	10,43	7,58	5,63	4,22	3,18	2,38	1,76	1,26	0,86	0,53							
0,14	24,04	18,77	15,38	11,62	8,45	6,27	4,71	3,54	2,66	1,96	1,41	0,96	0,60							
0,15	25,74	20,05	16,28	12,70	9,32	6,92	5,19	3,91	2,93	2,17	1,56	1,07	0,66							
0,16	27,24	21,26	17,28	13,95	10,19	7,56	5,67	4,27	3,21	2,37	1,71	1,17	0,72							
0,17	28,70	22,34	18,14	15,05	11,06	8,21	6,16	4,64	3,48	2,57	1,85	1,27	0,79							
0,18	30,09	23,41	18,99	15,75	11,92	8,85	6,64	5,0	3,75	2,78	2,00	1,37	0,85							
0,19	31,46	24,46	19,83	16,53	12,79	9,50	7,13	5,37	4,03	2,98	2,15	1,47	0,92							
0,20	32,80	25,49	20,65	17,20	13,66	10,14	7,61	5,74	4,30	3,18	2,3	1,57	0,98							

Maximum values of the variable load Q (kN/m²), $\psi_2=0,60$

Steel sheet thickness: $t=0,80\text{mm}$, Concrete: C20/25, Steel reinforcement: B500C

Fire resistance: 30 minutes

Plate thickness	Span L (m)																			
h_t (m)	1,00	1,25	1,50	1,75	2,00	2,25	2,50	2,75	3,00	3,25	3,50	3,75	4,00	4,25	4,50	4,75	5,00	5,25	5,50	
0,13	23,00	18,10	14,74	11,12	8,12	6,04	4,56	3,46	2,61	1,96	1,43	1,01	0,66							
0,14	24,79	19,35	15,75	12,29	9,04	6,74	5,08	3,85	2,92	2,18	1,60	1,13	0,74							
0,15	26,25	20,58	16,66	13,64	9,97	7,43	5,61	4,25	3,22	2,41	1,77	1,25	0,82							
0,16	27,89	21,78	17,54	14,77	10,90	8,12	6,09	4,65	3,52	2,64	1,94	1,37	0,90	0,52						
0,17	29,21	22,88	18,51	15,48	11,83	8,82	6,65	5,05	3,82	2,86	2,10	1,49	0,98	0,56						
0,18	30,60	23,93	19,46	16,28	12,73	9,51	7,18	5,45	4,12	3,09	2,27	1,60	1,06	0,60						
0,19	32,06	25,05	20,29	16,96	13,61	10,20	7,70	5,84	4,43	3,32	2,44	1,72	1,14	0,65						
0,20	33,56	26,11	21,11	17,63	14,57	10,89	8,23	6,24	4,73	3,54	2,60	1,84	1,22	0,70						

Maximum values of the variable load Q (kN/m²), $\psi_2=0,60$

Steel sheet thickness: $t=1,00\text{mm}$, Concrete: C20/25, Steel reinforcement: B500C

Fire resistance: 30 minutes

Plate thickness	Span L (m)																			
h_t (m)	1,00	1,25	1,50	1,75	2,00	2,25	2,50	2,75	3,00	3,25	3,50	3,75	4,00	4,25	4,50	4,75	5,00	5,25	5,50	
0,13	25,02	19,69	15,91	13,36	10,08	7,54	5,72	4,38	3,36	2,56	1,93	1,42	1,00	0,66						
0,14	26,89	21,03	17,02	14,31	11,25	8,46	6,43	4,92	3,78	2,89	2,18	1,61	1,14	0,76						
0,15	28,55	22,35	18,22	15,21	12,94	9,82	7,54	5,85	4,55	3,55	2,75	2,10	1,57	1,12	0,75					
0,16	30,28	23,55	19,25	16,16	13,75	10,69	8,25	6,39	4,98	3,88	3,01	2,30	1,72	1,23	0,83					
0,17	31,90	24,85	20,25	16,95	14,45	11,65	8,95	6,94	5,41	4,22	3,27	2,50	1,87	1,34	0,90	0,53				
0,18	33,25	26,00	21,25	17,66	15,15	12,48	9,66	7,49	5,84	4,55	3,52	2,70	2,01	1,45	0,97	0,57				
0,19	34,81	27,22	22,15	18,34	15,80	13,35	10,36	8,04	6,27	4,88	3,78	2,90	2,16	1,56	1,05	0,62				
0,20	36,34	28,44	23,10	19,10	16,43	14,20	10,95	8,59	6,69	5,22	4,04	3,10	2,31	1,67	1,12	0,66				

Maximum values of the variable load Q (kN/m²), $\psi_2=0,60$

Steel sheet thickness: $t=1,25\text{mm}$, Concrete: C20/25, Steel reinforcement: B500C

Fire resistance: 30 minutes

Plate thickness	Span L (m)																			
h_t (m)	1,00	1,25	1,50	1,75	2,00	2,25	2,50	2,75	3,00	3,25	3,50	3,75	4,00	4,25	4,50	4,75	5,00	5,25	5,50	
0,13	27,24	21,39	17,48	14,60	12,60	9,95	7,67	5,99	4,71	3,71	2,92	2,28	1,76	1,32	0,96					
0,14	29,10	22,89	18,70	15,71	13,46	11,20	8,69	6,79	5,34	4,22	3,33	2,61	2,02	1,53	1,12	0,77				
0,15	30,80	24,14	19,84	16,68	14,28	12,36	9,71	7,59	5,98	4,73	3,73	2,93	2,27	1,73	1,27	0,89	0,56			
0,16	32,57	25,73	20,91	17,59	15,05	13,10	10,70	8,39	6,62	5,24	4,14	3,26	2,53	1,93	1,43	1,00	0,64			
0,17	34,26	27,05	21,96	18,39	15,77	13,75	11,65	9,16	7,33	5,85	4,67	3,72	2,93	2,29	1,74	1,28	0,88	0,54		
0,18	35,95	28,15	23,15	19,27	16,55	14,25	12,55	9,92	7,91	6,31	5,04	4,01	3,17	2,47	1,88	1,38	0,96	0,59		
0,19	37,60	29,52	24,15	20,04	17,25	14,82	13,10	10,67	8,49	6,78	5,41	4,31	3,41	2,66	2,03	1,49	1,03	0,64		
0,20	39,28	30,78	25,00	20,90	17,98	15,55	13,55	11,40	9,05	7,24	5,79	4,61	3,64	2,84	2,17	1,60	1,11	0,69		

Maximum values of the variable load Q (kN/m²), $\psi_2=0,60$

Without additional reinforcement.
 1ø6
 1ø8
 1ø10
 1ø12
 1ø14

Fire dimensional sizing boards Symdeck 73

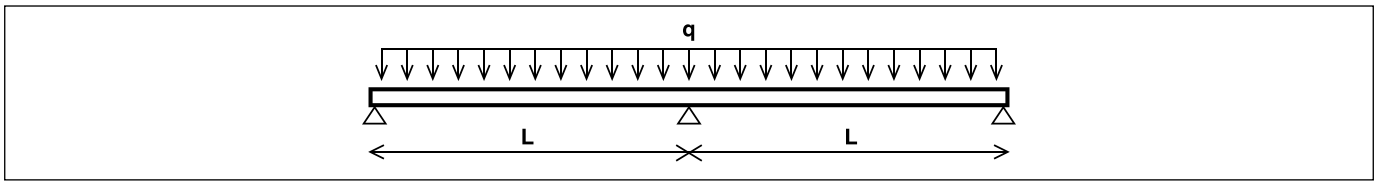

Reinforcement in positions of bending moments								
h_t (m)	0,13	0,14	0,15	0,16	0,17	0,18	0,19	0,20
Diameter (mm) / Space (mm)	Ø8/200	Ø8/200	Ø8/150	Ø8/150	Ø10/200	Ø10/200	Ø10/150	Ø10/150

Steel sheet thickness: $t=0,75\text{mm}$, Concrete: C20/25, Steel reinforcement: B500C

Fire resistance: 60 minutes

Plate thickness	Span L (m)																			
h_t (m)	1,00	1,25	1,50	1,75	2,00	2,25	2,50	2,75	3,00	3,25	3,50	3,75	4,00	4,25	4,50	4,75	5,00	5,25	5,50	
0,13	22,58	17,67	14,36	10,43	7,58	5,63	4,22	3,18	2,38	1,76	1,26	0,86	0,53							
0,14	24,04	18,77	15,38	11,62	8,45	6,27	4,71	3,54	2,66	1,96	1,41	0,96	0,60							
0,15	25,74	20,05	16,28	12,70	9,32	6,92	5,19	3,91	2,93	2,17	1,56	1,07	0,66							
0,16	27,24	21,26	17,28	13,95	10,19	7,56	5,67	4,27	3,21	2,37	1,71	1,17	0,72							
0,17	28,70	22,34	18,14	15,05	11,06	8,21	6,16	4,64	3,48	2,57	1,85	1,27	0,79							
0,18	30,09	23,41	18,99	15,75	11,92	8,85	6,64	5,00	3,75	2,78	2,00	1,37	0,85							
0,19	31,46	24,46	19,83	16,53	12,79	9,50	7,13	5,37	4,03	2,98	2,15	1,47	0,92							
0,20	32,80	25,49	20,65	17,20	13,66	10,14	7,61	5,74	4,30	3,18	2,3	1,57	0,98							

Maximum values of the variable load Q (kN/m²), $\psi_2=0,60$

Steel sheet thickness: $t=0,80\text{mm}$, Concrete: C20/25, Steel reinforcement: B500C

Fire resistance: 60 minutes

Plate thickness	Span L (m)																			
h_t (m)	1,00	1,25	1,50	1,75	2,00	2,25	2,50	2,75	3,00	3,25	3,50	3,75	4,00	4,25	4,50	4,75	5,00	5,25	5,50	
0,13	23,00	18,10	14,74	11,12	8,12	6,04	4,56	3,46	2,61	1,96	1,43	1,01	0,66							
0,14	24,79	19,35	15,75	12,29	9,04	6,74	5,08	3,85	2,92	2,18	1,60	1,13	0,74							
0,15	26,25	20,58	16,66	13,64	9,97	7,43	5,61	4,25	3,22	2,41	1,77	1,25	0,82							
0,16	27,89	21,78	17,54	14,77	10,90	8,12	6,09	4,65	3,52	2,64	1,94	1,37	0,90	0,52						
0,17	29,21	22,88	18,51	15,48	11,83	8,82	6,65	5,05	3,82	2,86	2,10	1,49	0,98	0,56						
0,18	30,60	23,93	19,46	16,28	12,73	9,51	7,18	5,45	4,12	3,09	2,27	1,60	1,06	0,60						
0,19	32,06	25,05	20,29	16,96	13,61	10,20	7,70	5,84	4,43	3,32	2,44	1,72	1,14	0,65						
0,20	33,56	26,11	21,11	17,63	14,57	10,89	8,23	6,24	4,73	3,54	2,6	1,84	1,22	0,70						

Maximum values of the variable load Q (kN/m²), $\psi_2=0,60$

Steel sheet thickness: $t=1,00\text{mm}$, Concrete: C20/25, Steel reinforcement: B500C

Fire resistance: 60 minutes

Plate thickness	Span L (m)																			
h_t (m)	1,00	1,25	1,50	1,75	2,00	2,25	2,50	2,75	3,00	3,25	3,50	3,75	4,00	4,25	4,50	4,75	5,00	5,25	5,50	
0,13	25,02	19,69	15,91	13,36	10,08	7,54	5,72	4,38	3,36	2,56	1,93	1,42	1,00	0,66						
0,14	26,89	21,03	17,02	14,31	11,25	8,46	6,43	4,92	3,78	2,89	2,18	1,61	1,14	0,76						
0,15	28,55	22,35	18,22	15,21	12,94	9,82	7,54	5,85	4,55	3,55	2,75	2,10	1,57	1,12	0,75					
0,16	30,28	23,55	19,25	16,16	13,75	10,69	8,25	6,39	4,98	3,88	3,01	2,30	1,72	1,23	0,83					
0,17	31,90	24,85	20,25	16,95	14,45	11,65	8,95	6,94	5,41	4,22	3,27	2,50	1,87	1,34	0,90	0,53				
0,18	33,25	26,00	21,25	17,66	15,15	12,48	9,66	7,49	5,84	4,55	3,52	2,70	2,01	1,45	0,97	0,57				
0,19	34,81	27,22	22,15	18,34	15,80	13,35	10,36	8,04	6,27	4,88	3,78	2,90	2,16	1,56	1,05	0,62				
0,20	36,34	28,44	23,10	19,10	16,43	14,20	10,95	8,59	6,69	5,22	4,04	3,10	2,31	1,67	1,12	0,66				

Maximum values of the variable load Q (kN/m²), $\psi_2=0,60$

Steel sheet thickness: $t=1,25\text{mm}$, Concrete: C20/25, Steel reinforcement: B500C

Fire resistance: 60 minutes

Plate thickness	Span L (m)																			
h_t (m)	1,00	1,25	1,50	1,75	2,00	2,25	2,50	2,75	3,00	3,25	3,50	3,75	4,00	4,25	4,50	4,75	5,00	5,25	5,50	
0,13	27,24	21,39	17,48	14,6	12,60	9,95	7,67	5,99	4,71	3,71	2,92	2,28	1,76	1,32	0,96					
0,14	29,10	22,89	18,70	15,71	13,46	11,20	8,69	6,79	5,34	4,22	3,33	2,61	2,02	1,53	1,12	0,77				
0,15	30,80	24,14	19,84	16,68	14,28	12,36	9,71	7,59	5,98	4,73	3,73	2,93	2,27	1,73	1,27	0,89	0,56			
0,16	32,57	25,73	20,91	17,59	15,05	13,10	10,70	8,39	6,62	5,24	4,14	3,26	2,53	1,93	1,43	1,00	0,64			
0,17	34,26	27,05	21,96	18,39	15,77	13,75	11,65	9,16	7,33	5,85	4,67	3,72	2,93	2,29	1,74	1,28	0,88	0,54		
0,18	35,95	28,15	23,15	19,27	16,55	14,25	12,55	9,92	7,91	6,31	5,04	4,01	3,17	2,47	1,88	1,38	0,96	0,59		
0,19	37,60	29,52	24,15	20,04	17,25	14,82	13,10	10,67	8,49	6,78	5,41	4,31	3,41	2,66	2,03	1,49	1,03	0,64		
0,20	39,28	30,78	25,00	20,9	17,98	15,55	13,55	11,40	9,05	7,24	5,79	4,61	3,64	2,84	2,17	1,60	1,11	0,69		

Maximum values of the variable load Q (kN/m²), $\psi_2=0,60$

1Ø14 1Ø12 1Ø10 1Ø8 1Ø6 Without additional reinforcement.

Fire dimensional sizing boards Symdeck 73

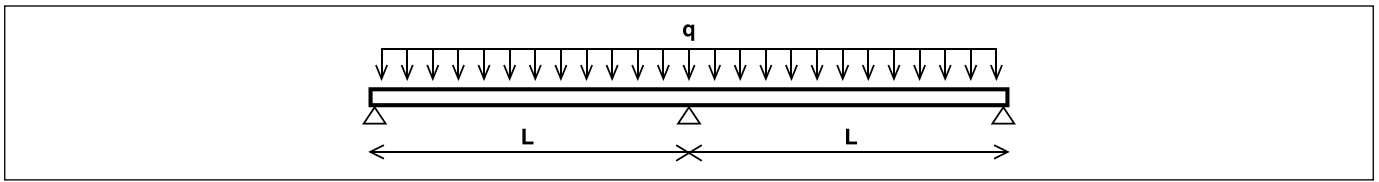

Reinforcement in positions of bending moments								
h_i (m)	0,13	0,14	0,15	0,16	0,17	0,18	0,19	0,20
Diameter (mm) / Space (mm)	Ø8/200	Ø8/200	Ø8/150	Ø8/150	Ø10/200	Ø10/200	Ø10/150	Ø10/150

Steel sheet thickness: $t=0,75\text{mm}$, Concrete: C20/25, Steel reinforcement: B500C **Fire resistance: 90 minutes**

Plate thickness	Span L (m)																			
h_i (m)	1,00	1,25	1,50	1,75	2,00	2,25	2,50	2,75	3,00	3,25	3,50	3,75	4,00	4,25	4,50	4,75	5,00	5,25	5,50	
0,13	22,58	17,67	14,36	10,43	7,58	5,63	4,22	3,18	2,38	1,76	1,26	0,86	0,53							
0,14	24,04	18,77	15,38	11,62	8,45	6,27	4,71	3,54	2,66	1,96	1,41	0,96	0,60							
0,15	25,74	20,05	16,28	12,70	9,32	6,92	5,19	3,91	2,93	2,17	1,56	1,07	0,66							
0,16	27,24	21,26	17,28	13,95	10,19	7,56	5,67	4,27	3,21	2,37	1,71	1,17	0,72							
0,17	28,70	22,34	18,14	15,05	11,06	8,21	6,16	4,64	3,48	2,57	1,85	1,27	0,79							
0,18	30,09	23,41	18,99	15,75	11,92	8,85	6,64	5,00	3,75	2,78	2,00	1,37	0,85							
0,19	31,46	24,46	19,83	16,53	12,79	9,50	7,13	5,37	4,03	2,98	2,15	1,47	0,92							
0,20	32,80	25,49	20,65	17,20	13,66	10,14	7,61	5,74	4,30	3,18	2,30	1,57	0,98							

Maximum values of the variable load Q (kN/m²), $\psi_2=0,60$

Steel sheet thickness: $t=0,80\text{mm}$, Concrete: C20/25, Steel reinforcement: B500C **Fire resistance: 90 minutes**

Plate thickness	Span L (m)																			
h_i (m)	1,00	1,25	1,50	1,75	2,00	2,25	2,50	2,75	3,00	3,25	3,50	3,75	4,00	4,25	4,50	4,75	5,00	5,25	5,50	
0,13	23,90	18,10	14,74	11,12	8,12	6,04	4,56	3,46	2,61	1,96	1,43	1,01	0,66							
0,14	24,79	19,35	15,75	12,29	9,04	6,74	5,08	3,85	2,92	2,18	1,60	1,13	0,74							
0,15	26,25	20,58	16,66	13,64	9,97	7,43	5,61	4,25	3,22	2,41	1,77	1,25	0,82							
0,16	27,89	21,78	17,54	14,77	10,9	8,12	6,09	4,65	3,52	2,64	1,94	1,37	0,90	0,52						
0,17	29,21	22,88	18,51	15,48	11,83	8,82	6,65	5,05	3,82	2,86	2,10	1,49	0,98	0,56						
0,18	30,60	23,93	19,46	16,28	12,73	9,51	7,18	5,45	4,12	3,09	2,27	1,60	1,06	0,60						
0,19	32,06	25,05	20,29	16,96	13,61	10,20	7,70	5,84	4,43	3,32	2,44	1,72	1,14	0,65						
0,20	33,56	26,11	21,11	17,63	14,57	10,89	8,23	6,24	4,73	3,54	2,60	1,84	1,22	0,70						

Maximum values of the variable load Q (kN/m²), $\psi_2=0,60$

Steel sheet thickness: $t=1,00\text{mm}$, Concrete: C20/25, Steel reinforcement: B500C **Fire resistance: 90 minutes**

Plate thickness	Span L (m)																			
h_i (m)	1,00	1,25	1,50	1,75	2,00	2,25	2,50	2,75	3,00	3,25	3,50	3,75	4,00	4,25	4,50	4,75	5,00	5,25	5,50	
0,13	25,92	19,69	15,91	13,36	10,98	7,54	5,72	4,38	3,36	2,56	1,93	1,42	1,00	0,66						
0,14	26,89	21,03	17,02	14,31	11,25	8,46	6,43	4,92	3,78	2,89	2,18	1,61	1,14	0,76						
0,15	28,55	22,35	18,22	15,21	12,94	9,82	7,54	5,85	4,55	3,55	2,75	2,10	1,57	1,12	0,75					
0,16	30,28	23,55	19,25	16,16	13,75	10,69	8,25	6,39	4,98	3,88	3,01	2,30	1,72	1,23	0,83					
0,17	31,90	24,85	20,25	16,95	14,45	11,65	8,95	6,94	5,41	4,22	3,27	2,50	1,87	1,34	0,90	0,53				
0,18	33,25	26,00	21,25	17,66	15,15	12,48	9,66	7,49	5,84	4,55	3,52	2,70	2,01	1,45	0,97	0,57				
0,19	34,81	27,22	22,15	18,34	15,80	13,35	10,36	8,04	6,27	4,88	3,78	2,90	2,16	1,56	1,05	0,62				
0,20	36,34	28,44	23,10	19,10	16,43	14,20	10,95	8,59	6,69	5,22	4,04	3,10	2,31	1,67	1,12	0,66				

Maximum values of the variable load Q (kN/m²), $\psi_2=0,60$

Steel sheet thickness: $t=1,25\text{mm}$, Concrete: C20/25, Steel reinforcement: B500C **Fire resistance: 90 minutes**

Plate thickness	Span L (m)																			
h_i (m)	1,00	1,25	1,50	1,75	2,00	2,25	2,50	2,75	3,00	3,25	3,50	3,75	4,00	4,25	4,50	4,75	5,00	5,25	5,50	
0,13	27,24	21,39	17,48	14,60	12,60	9,95	7,67	5,99	4,71	3,71	2,92	2,28	1,76	1,32	0,96					
0,14	29,10	22,89	18,70	15,71	13,46	11,20	8,69	6,79	5,34	4,22	3,33	2,61	2,02	1,53	1,12	0,77				
0,15	30,80	24,14	19,84	16,68	14,28	12,36	9,71	7,59	5,98	4,73	3,73	2,93	2,27	1,73	1,27	0,89	0,56			
0,16	32,57	25,73	20,91	17,59	15,05	13,10	10,70	8,39	6,62	5,24	4,14	3,26	2,53	1,93	1,43	1,00	0,64			
0,17	34,26	27,05	21,96	18,39	15,77	13,75	11,65	9,16	7,33	5,85	4,67	3,72	2,93	2,29	1,74	1,28	0,88	0,54		
0,18	35,95	28,15	23,15	19,27	16,55	14,25	12,55	9,92	7,91	6,31	5,04	4,01	3,17	2,47	1,88	1,38	0,96	0,59		
0,19	37,60	29,52	24,15	20,04	17,25	14,82	13,10	10,67	8,49	6,78	5,41	4,31	3,41	2,66	2,03	1,49	1,03	0,64		
0,20	39,28	30,78	25,00	20,90	17,98	15,55	13,55	11,40	9,05	7,24	5,79	4,61	3,64	2,84	2,17	1,60	1,11	0,69		

Maximum values of the variable load Q (kN/m²), $\psi_2=0,60$

□ Without additional reinforcement. □ 1ø6 □ 1ø8 □ 1ø10 □ 1ø12 □ 1ø14

Fire dimensional sizing boards Symdeck 73

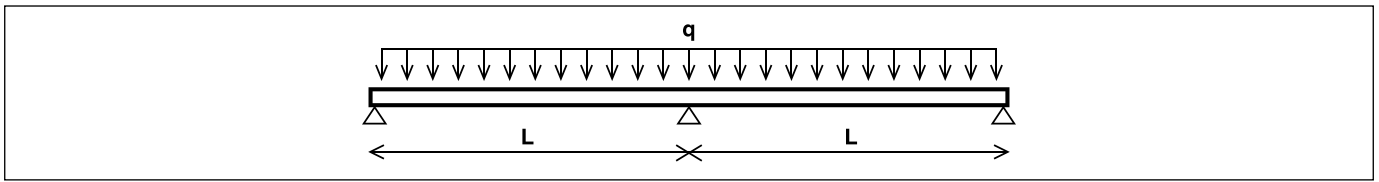

Reinforcement in positions of bending moments								
h_t (m)	0,13	0,14	0,15	0,16	0,17	0,18	0,19	0,20
Diameter (mm) / Space (mm)	Ø8/200	Ø8/200	Ø8/150	Ø8/150	Ø10/200	Ø10/200	Ø10/150	Ø10/150

Steel sheet thickness: $t=0,75\text{mm}$, Concrete: C20/25, Steel reinforcement: B500C **Fire resistance: 120 minutes**

Plate thickness	Span L (m)																			
h_t (m)	1,00	1,25	1,50	1,75	2,00	2,25	2,50	2,75	3,00	3,25	3,50	3,75	4,00	4,25	4,50	4,75	5,00	5,25	5,50	
0,13	22,58	17,67	14,36	10,43	7,58	5,63	4,22	3,18	2,38	1,76	1,26	0,86	0,53							
0,14	24,04	18,77	15,38	11,62	8,45	6,27	4,71	3,54	2,66	1,96	1,41	0,96	0,60							
0,15	25,74	20,05	16,28	12,70	9,32	6,92	5,19	3,91	2,93	2,17	1,56	1,07	0,66							
0,16	27,24	21,26	17,28	13,95	10,19	7,56	5,67	4,27	3,21	2,37	1,71	1,17	0,72							
0,17	28,70	22,34	18,14	15,05	11,06	8,21	6,16	4,64	3,48	2,57	1,85	1,27	0,79							
0,18	30,09	23,41	18,99	15,75	11,92	8,85	6,64	5,00	3,75	2,78	2,00	1,37	0,85							
0,19	31,46	24,46	19,83	16,53	12,79	9,50	7,13	5,37	4,03	2,98	2,15	1,47	0,92							
0,20	32,80	25,49	20,65	17,20	13,66	10,14	7,61	5,74	4,30	3,18	2,30	1,57	0,98							

Maximum values of the variable load Q (kN/m²), $\psi_2=0,60$

Steel sheet thickness: $t=0,80\text{mm}$, Concrete: C20/25, Steel reinforcement: B500C **Fire resistance: 120 minutes**

Plate thickness	Span L (m)																			
h_t (m)	1,00	1,25	1,50	1,75	2,00	2,25	2,50	2,75	3,00	3,25	3,50	3,75	4,00	4,25	4,50	4,75	5,00	5,25	5,50	
0,13	23,00	18,10	14,74	11,12	8,12	6,04	4,56	3,46	2,61	1,96	1,43	1,01	0,66							
0,14	24,79	19,35	15,75	12,29	9,04	6,74	5,08	3,85	2,92	2,18	1,60	1,13	0,74							
0,15	26,25	20,58	16,66	13,64	9,97	7,43	5,61	4,25	3,22	2,41	1,77	1,25	0,82							
0,16	27,89	21,78	17,54	14,77	10,90	8,12	6,09	4,65	3,52	2,64	1,94	1,37	0,90	0,52						
0,17	29,21	22,88	18,51	15,48	11,83	8,82	6,65	5,05	3,82	2,86	2,10	1,49	0,98	0,56						
0,18	30,60	23,93	19,46	16,28	12,73	9,51	7,18	5,45	4,12	3,09	2,27	1,60	1,06	0,60						
0,19	32,06	25,05	20,29	16,96	13,61	10,20	7,70	5,84	4,43	3,32	2,44	1,72	1,14	0,65						
0,20	33,56	26,11	21,11	17,63	14,57	10,89	8,23	6,24	4,73	3,54	2,60	1,84	1,22	0,70						

Maximum values of the variable load Q (kN/m²), $\psi_2=0,60$

Steel sheet thickness: $t=1,00\text{mm}$, Concrete: C20/25, Steel reinforcement: B500C **Fire resistance: 120 minutes**

Plate thickness	Span L (m)																			
h_t (m)	1,00	1,25	1,50	1,75	2,00	2,25	2,50	2,75	3,00	3,25	3,50	3,75	4,00	4,25	4,50	4,75	5,00	5,25	5,50	
0,13	25,92	19,69	15,91	13,36	10,98	7,54	5,72	4,38	3,36	2,56	1,93	1,42	1,00	0,66						
0,14	26,89	21,03	17,02	14,31	11,25	8,46	6,43	4,92	3,78	2,89	2,18	1,61	1,14	0,76						
0,15	28,55	22,35	18,22	15,21	12,94	9,82	7,54	5,85	4,55	3,55	2,75	2,10	1,57	1,12	0,75					
0,16	30,28	23,55	19,25	16,16	13,75	10,69	8,25	6,39	4,98	3,88	3,01	2,30	1,72	1,23	0,83					
0,17	31,90	24,85	20,25	16,95	14,45	11,65	8,95	6,94	5,41	4,22	3,27	2,50	1,87	1,34	0,90	0,53				
0,18	33,25	26,00	21,25	17,66	15,15	12,48	9,66	7,49	5,84	4,55	3,52	2,70	2,01	1,45	0,97	0,57				
0,19	34,81	27,22	22,15	18,34	15,80	13,35	10,36	8,04	6,27	4,88	3,78	2,90	2,16	1,56	1,05	0,62				
0,20	36,34	28,44	23,10	19,10	16,43	14,20	10,95	8,59	6,69	5,22	4,04	3,10	2,31	1,67	1,12	0,66				

Maximum values of the variable load Q (kN/m²), $\psi_2=0,60$

Steel sheet thickness: $t=1,25\text{mm}$, Concrete: C20/25, Steel reinforcement: B500C **Fire resistance: 120 minutes**

Plate thickness	Span L (m)																			
h_t (m)	1,00	1,25	1,50	1,75	2,00	2,25	2,50	2,75	3,00	3,25	3,50	3,75	4,00	4,25	4,50	4,75	5,00	5,25	5,50	
0,13	27,24	21,39	17,48	14,60	12,60	9,95	7,67	5,99	4,71	3,71	2,92	2,28	1,76	1,32	0,96					
0,14	29,10	22,89	18,70	15,71	13,46	11,20	8,69	6,79	5,34	4,22	3,33	2,61	2,02	1,53	1,12	0,77				
0,15	30,80	24,14	19,84	16,68	14,28	12,36	9,71	7,59	5,98	4,73	3,73	2,93	2,27	1,73	1,27	0,89	0,56			
0,16	32,57	25,73	20,91	17,59	15,05	13,10	10,70	8,39	6,62	5,24	4,14	3,26	2,53	1,93	1,43	1,00	0,64			
0,17	34,26	27,05	21,96	18,39	15,77	13,75	11,65	9,16	7,33	5,85	4,67	3,72	2,93	2,29	1,74	1,28	0,88	0,54		
0,18	35,95	28,15	23,15	19,27	16,55	14,25	12,55	9,92	7,91	6,31	5,04	4,01	3,17	2,47	1,88	1,38	0,96	0,59		
0,19	37,60	29,52	24,15	20,04	17,25	14,82	13,10	10,67	8,49	6,78	5,41	4,31	3,41	2,66	2,03	1,49	1,03	0,64		
0,20	39,28	30,78	25,00	20,90	17,98	15,55	13,55	11,40	9,05	7,24	5,79	4,61	3,64	2,84	2,17	1,60	1,11	0,69		

Maximum values of the variable load Q (kN/m²), $\psi_2=0,60$

1Ø14 1Ø12 1Ø10 1Ø8 1Ø6 Without additional reinforcement.

Fire dimensional sizing boards Symdeck 73

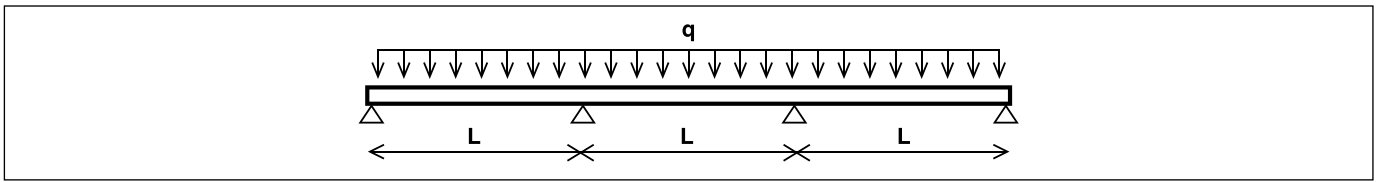

Reinforcement in positions of bending moments								
h_t (m)	0,13	0,14	0,15	0,16	0,17	0,18	0,19	0,20
Diameter (mm) / Space (mm)	Ø8/200	Ø8/200	Ø8/150	Ø8/150	Ø10/200	Ø10/200	Ø10/150	Ø10/150

Steel sheet thickness: $t=0,75\text{mm}$, Concrete: C20/25, Steel reinforcement: B500C

Fire resistance: 30 minutes

Plate thickness	Span L (m)																			
h_t (m)	1,00	1,25	1,50	1,75	2,00	2,25	2,50	2,75	3,00	3,25	3,50	3,75	4,00	4,25	4,50	4,75	5,00	5,25	5,50	
0,13	27,24	21,39	17,48	14,60	12,60	9,95	7,67	5,99	4,71	3,71	2,92	2,28	1,76	1,32	0,96					
0,14	29,10	22,89	18,70	15,71	13,46	11,20	8,69	6,79	5,34	4,22	3,33	2,61	2,02	1,53	1,12	0,77				
0,15	30,80	24,14	19,84	16,68	14,28	12,36	9,71	7,59	5,98	4,73	3,73	2,93	2,27	1,73	1,27	0,89	0,56			
0,16	32,57	25,73	20,91	17,59	15,05	13,10	10,70	8,39	6,62	5,24	4,14	3,26	2,53	1,93	1,43	1,00	0,64			
0,17	34,26	27,05	21,96	18,39	15,77	13,75	11,65	9,16	7,33	5,85	4,67	3,72	2,93	2,29	1,74	1,28	0,88	0,54		
0,18	35,95	28,15	23,15	19,27	16,55	14,25	12,55	9,92	7,91	6,31	5,04	4,01	3,17	2,47	1,88	1,38	0,96	0,59		
0,19	37,60	29,52	24,15	20,04	17,25	14,82	13,10	10,67	8,49	6,78	5,41	4,31	3,41	2,66	2,03	1,49	1,03	0,64		
0,20	39,28	30,78	25,00	20,90	17,98	15,55	13,55	11,40	9,05	7,24	5,79	4,61	3,64	2,84	2,17	1,60	1,11	0,69		

Maximum values of the variable load Q (kN/m²), $\psi_2=0,60$

Steel sheet thickness: $t=0,80\text{mm}$, Concrete: C20/25, Steel reinforcement: B500C

Fire resistance: 30 minutes

Plate thickness	Span L (m)																			
h_t (m)	1,00	1,25	1,50	1,75	2,00	2,25	2,50	2,75	3,00	3,25	3,50	3,75	4,00	4,25	4,50	4,75	5,00	5,25	5,50	
0,13	24,06	18,97	15,40	11,67	8,54	6,38	4,83	3,68	2,81	2,12	1,58	1,14	0,77							
0,14	25,82	20,17	16,55	12,95	9,51	7,11	5,39	4,11	3,13	2,37	1,76	1,27	0,87	0,53						
0,15	27,55	21,55	17,55	14,30	10,49	7,84	5,94	4,53	3,45	2,61	1,94	1,40	0,96	0,59						
0,16	29,16	22,72	18,50	15,55	11,47	8,57	6,50	4,95	3,78	2,86	2,13	1,54	1,05	0,64						
0,17	30,64	23,86	19,45	16,30	12,45	9,31	7,05	5,38	4,10	3,10	2,31	1,67	1,14	0,70						
0,18	32,10	25,08	20,40	17,10	13,40	10,04	7,61	5,80	4,43	3,35	2,49	1,80	1,23	0,76						
0,19	33,63	26,28	21,35	17,80	14,35	10,77	8,16	6,23	4,75	3,60	2,68	1,93	1,32	0,82						
0,20	35,14	27,36	22,20	18,45	15,35	11,50	8,72	6,65	5,07	3,84	2,86	2,07	1,42	0,87						

Maximum values of the variable load Q (kN/m²), $\psi_2=0,60$

Steel sheet thickness: $t=1,00\text{mm}$, Concrete: C20/25, Steel reinforcement: B500C

Fire resistance: 30 minutes

Plate thickness	Span L (m)																			
h_t (m)	1,00	1,25	1,50	1,75	2,00	2,25	2,50	2,75	3,00	3,25	3,50	3,75	4,00	4,25	4,50	4,75	5,00	5,25	5,50	
0,13	26,24	20,51	16,80	14,12	11,02	8,40	6,47	5,03	3,94	3,08	2,40	1,85	1,40	1,03	0,71					
0,14	28,09	21,98	18,00	15,10	12,35	9,37	7,21	5,61	4,39	3,44	2,68	2,07	1,57	1,15	0,80	0,50				
0,15	29,91	23,45	19,05	16,05	13,53	10,33	7,96	6,19	4,85	3,80	2,96	2,29	1,73	1,27	0,89	0,56				
0,16	31,51	24,63	20,15	16,95	14,46	11,30	8,70	6,77	5,30	4,16	3,24	2,50	1,90	1,40	0,97	0,61				
0,17	33,28	25,96	21,25	17,70	15,20	12,25	9,45	7,35	5,76	4,51	3,52	2,72	2,06	1,52	1,06	0,67				
0,18	34,93	27,18	22,25	18,60	15,90	13,09	10,19	7,93	6,21	4,87	3,80	2,94	2,23	1,64	1,15	0,73				
0,19	36,25	28,57	23,15	19,45	16,59	14,05	10,95	8,51	6,67	5,23	4,08	3,16	2,40	1,76	1,23	0,78				
0,20	37,94	29,74	24,05	20,22	17,18	14,94	11,65	9,09	7,12	5,59	4,36	3,37	2,56	1,89	1,32	0,84				

Maximum values of the variable load Q (kN/m²), $\psi_2=0,60$

Steel sheet thickness: $t=1,25\text{mm}$, Concrete: C20/25, Steel reinforcement: B500C

Fire resistance: 30 minutes

Plate thickness	Span L (m)																			
h_t (m)	1,00	1,25	1,50	1,75	2,00	2,25	2,50	2,75	3,00	3,25	3,50	3,75	4,00	4,25	4,50	4,75	5,00	5,25	5,50	
0,13	28,46	22,36	18,29	15,39	13,20	10,85	8,45	6,65	5,30	4,25	3,40	2,72	2,15	1,70	1,31	0,98	0,70			
0,14	30,48	23,93	19,58	16,46	14,10	12,10	9,41	7,43	5,92	4,74	3,80	3,02	2,42	1,90	1,47	1,10	0,78			
0,15	32,45	25,45	20,67	17,45	14,95	12,95	10,32	8,20	6,53	5,23	4,20	3,36	2,67	2,10	1,62	1,21	0,87	0,57		
0,16	34,08	26,90	21,89	18,40	15,80	13,75	11,35	8,97	7,14	5,72	4,59	3,67	2,92	2,30	1,78	1,33	0,95	0,63		
0,17	35,84	28,25	23,08	19,25	16,50	14,45	12,30	9,67	7,76	6,21	4,99	4,00	3,18	2,50	1,94	1,45	1,04	0,69		
0,18	37,67	29,70	24,25	20,30	17,25	15,10	13,25	10,45	8,37	6,71	5,38	4,31	3,43	2,71	2,09	1,57	1,13	0,75		
0,19	39,36	30,95	25,30	21,20	18,00	15,65	13,80	11,25	8,99	7,20	5,78	4,63	3,69	2,91	2,25	1,69	1,22	0,81		
0,20	40,96	32,22	26,27	22,10	18,88	16,20	14,25	12,02	9,57	7,69	6,18	4,95	3,95	3,11	2,41	1,81	1,30	0,87		

Maximum values of the variable load Q (kN/m²), $\psi_2=0,60$

Without additional reinforcement.
 1ø6
 1ø8
 1ø10
 1ø12
 1ø14

Fire dimensional sizing boards Symdeck 73

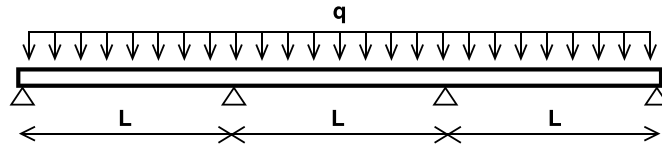

Reinforcement in positions of bending moments

h_t (m)	0,13	0,14	0,15	0,16	0,17	0,18	0,19	0,20
Diameter (mm) / Space (mm)	Ø8/200	Ø8/200	Ø8/150	Ø8/150	Ø10/200	Ø10/200	Ø10/150	Ø10/150

Steel sheet thickness: $t=0,75\text{mm}$, Concrete: C20/25, Steel reinforcement: B500C

Fire resistance: 60 minutes

Plate thickness	Span L (m)																		
h_t (m)	1,00	1,25	1,50	1,75	2,00	2,25	2,50	2,75	3,00	3,25	3,50	3,75	4,00	4,25	4,50	4,75	5,00	5,25	5,50
0,13	27,24	21,39	17,48	14,60	12,60	9,95	7,67	5,99	4,71	3,71	2,92	2,28	1,76	1,32	0,96				
0,14	29,10	22,89	18,70	15,71	13,46	11,20	8,69	6,79	5,34	4,22	3,33	2,61	2,02	1,53	1,12	0,77			
0,15	30,80	24,14	19,84	16,68	14,28	12,36	9,71	7,59	5,98	4,73	3,73	2,93	2,27	1,73	1,27	0,89	0,56		
0,16	32,57	25,73	20,91	17,59	15,05	13,10	10,70	8,39	6,62	5,24	4,14	3,26	2,53	1,93	1,43	1,00	0,64		
0,17	34,26	27,05	21,96	18,39	15,77	13,75	11,65	9,16	7,33	5,85	4,67	3,72	2,93	2,29	1,74	1,28	0,88	0,54	
0,18	35,95	28,15	23,15	19,27	16,55	14,25	12,55	9,92	7,91	6,31	5,04	4,01	3,17	2,47	1,88	1,38	0,96	0,59	
0,19	37,60	29,52	24,15	20,04	17,25	14,82	13,10	10,67	8,49	6,78	5,41	4,31	3,41	2,66	2,03	1,49	1,03	0,64	
0,20	39,28	30,78	25,00	20,90	17,98	15,55	13,55	11,40	9,05	7,24	5,79	4,61	3,64	2,84	2,17	1,60	1,11	0,69	

Maximum values of the variable load Q (kN/m²), $\psi_2=0,60$

Steel sheet thickness: $t=0,80\text{mm}$, Concrete: C20/25, Steel reinforcement: B500C

Fire resistance: 60 minutes

Plate thickness	Span L (m)																		
h_t (m)	1,00	1,25	1,50	1,75	2,00	2,25	2,50	2,75	3,00	3,25	3,50	3,75	4,00	4,25	4,50	4,75	5,00	5,25	5,50
0,13	24,06	18,97	15,40	11,67	8,54	6,38	4,83	3,68	2,81	2,12	1,58	1,14	0,77						
0,14	25,82	20,17	16,55	12,95	9,51	7,11	5,39	4,11	3,13	2,37	1,76	1,27	0,87	0,53					
0,15	27,55	21,55	17,55	14,30	10,49	7,84	5,94	4,53	3,45	2,61	1,94	1,40	0,96	0,59					
0,16	29,16	22,72	18,50	15,55	11,47	8,57	6,50	4,95	3,78	2,86	2,13	1,54	1,05	0,64					
0,17	30,64	23,86	19,45	16,30	12,45	9,31	7,05	5,38	4,10	3,10	2,31	1,67	1,14	0,70					
0,18	32,10	25,08	20,40	17,10	13,40	10,04	7,61	5,80	4,43	3,35	2,49	1,80	1,23	0,76					
0,19	33,63	26,28	21,35	17,80	14,35	10,77	8,16	6,23	4,75	3,60	2,68	1,93	1,32	0,82					
0,20	35,14	27,36	22,20	18,45	15,35	11,50	8,72	6,65	5,07	3,84	2,86	2,07	1,42	0,87					

Maximum values of the variable load Q (kN/m²), $\psi_2=0,60$

Steel sheet thickness: $t=1,00\text{mm}$, Concrete: C20/25, Steel reinforcement: B500C

Fire resistance: 60 minutes

Plate thickness	Span L (m)																		
h_t (m)	1,00	1,25	1,50	1,75	2,00	2,25	2,50	2,75	3,00	3,25	3,50	3,75	4,00	4,25	4,50	4,75	5,00	5,25	5,50
0,13	26,24	20,51	16,80	14,12	11,02	8,40	6,47	5,03	3,94	3,08	2,40	1,85	1,40	1,03	0,71				
0,14	28,09	21,98	18,00	15,10	12,35	9,37	7,21	5,61	4,39	3,44	2,68	2,07	1,57	1,15	0,80	0,50			
0,15	29,91	23,45	19,05	16,05	13,53	10,33	7,96	6,19	4,85	3,80	2,96	2,29	1,73	1,27	0,89	0,56			
0,16	31,51	24,63	20,15	16,95	14,46	11,30	8,70	6,77	5,30	4,16	3,24	2,50	1,90	1,40	0,97	0,61			
0,17	33,28	25,96	21,25	17,70	15,20	12,25	9,45	7,35	5,76	4,51	3,52	2,72	2,06	1,52	1,06	0,67			
0,18	34,93	27,18	22,25	18,60	15,90	13,09	10,19	7,93	6,21	4,87	3,80	2,94	2,23	1,64	1,15	0,73			
0,19	36,25	28,57	23,15	19,45	16,59	14,05	10,95	8,51	6,67	5,23	4,08	3,16	2,40	1,76	1,23	0,78			
0,20	37,94	29,74	24,05	20,22	17,18	14,94	11,65	9,09	7,12	5,59	4,36	3,37	2,56	1,89	1,32	0,84			

Maximum values of the variable load Q (kN/m²), $\psi_2=0,60$

Steel sheet thickness: $t=1,25\text{mm}$, Concrete: C20/25, Steel reinforcement: B500C

Fire resistance: 60 minutes

Plate thickness	Span L (m)																		
h_t (m)	1,00	1,25	1,50	1,75	2,00	2,25	2,50	2,75	3,00	3,25	3,50	3,75	4,00	4,25	4,50	4,75	5,00	5,25	5,50
0,13	28,46	22,36	18,29	15,39	13,20	10,85	8,45	6,65	5,30	4,25	3,40	2,72	2,15	1,70	1,31	0,98	0,70		
0,14	30,48	23,93	19,58	16,46	14,10	12,10	9,41	7,43	5,92	4,74	3,80	3,02	2,42	1,90	1,47	1,10	0,78		
0,15	32,45	25,45	20,67	17,45	14,95	12,95	10,32	8,20	6,53	5,23	4,20	3,36	2,67	2,10	1,62	1,21	0,87	0,57	
0,16	34,08	26,90	21,89	18,40	15,80	13,75	11,35	8,97	7,14	5,72	4,59	3,67	2,92	2,30	1,78	1,33	0,95	0,63	
0,17	35,84	28,25	23,08	19,25	16,50	14,45	12,30	9,67	7,76	6,21	4,99	4,00	3,18	2,50	1,94	1,45	1,04	0,69	
0,18	37,67	29,70	24,25	20,30	17,25	15,10	13,25	10,45	8,37	6,71	5,38	4,31	3,43	2,71	2,09	1,57	1,13	0,75	
0,19	39,36	30,95	25,30	21,20	18,00	15,65	13,80	11,25	8,99	7,20	5,78	4,63	3,69	2,91	2,25	1,69	1,22	0,81	
0,20	40,96	32,22	26,27	22,10	18,88	16,20	14,25	12,02	9,57	7,69	6,18	4,95	3,95	3,11	2,41	1,81	1,30	0,87	

Maximum values of the variable load Q (kN/m²), $\psi_2=0,60$

1ø14 1ø12 1ø10 1ø8 1ø6 Without additional reinforcement.

Fire dimensional sizing boards Symdeck 73

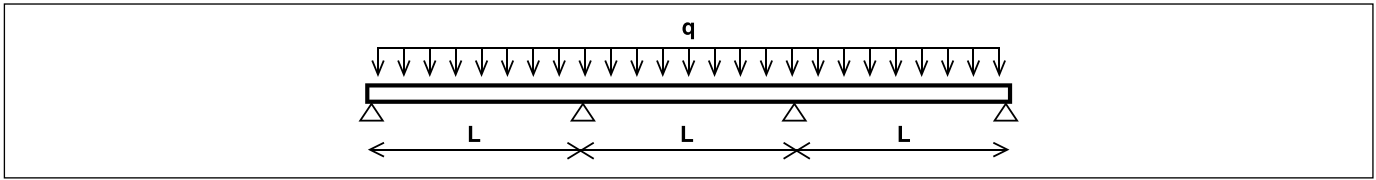

Reinforcement in positions of bending moments								
h_f (m)	0,13	0,14	0,15	0,16	0,17	0,18	0,19	0,20
Diameter (mm) / Space (mm)	Ø8/200	Ø8/200	Ø8/150	Ø8/150	Ø10/200	Ø10/200	Ø10/150	Ø10/150

Steel sheet thickness: $t=0,75\text{mm}$, Concrete: C20/25, Steel reinforcement: B500C **Fire resistance: 90 minutes**

Plate thickness	Span L (m)																			
h_f (m)	1,00	1,25	1,50	1,75	2,00	2,25	2,50	2,75	3,00	3,25	3,50	3,75	4,00	4,25	4,50	4,75	5,00	5,25	5,50	
0,13	27,24	21,39	17,48	14,60	12,60	9,95	7,67	5,99	4,71	3,71	2,92	2,28	1,76	1,32	0,96					
0,14	29,10	22,89	18,70	15,71	13,46	11,20	8,69	6,79	5,34	4,22	3,33	2,61	2,02	1,53	1,12	0,77				
0,15	30,80	24,14	19,84	16,68	14,28	12,36	9,71	7,59	5,98	4,73	3,73	2,93	2,27	1,73	1,27	0,89	0,56			
0,16	32,57	25,73	20,91	17,59	15,05	13,10	10,70	8,39	6,62	5,24	4,14	3,26	2,53	1,93	1,43	1,00	0,64			
0,17	34,26	27,05	21,96	18,39	15,77	13,75	11,65	9,16	7,33	5,85	4,67	3,72	2,93	2,29	1,74	1,28	0,88	0,54		
0,18	35,95	28,15	23,15	19,27	16,55	14,25	12,55	9,92	7,91	6,31	5,04	4,01	3,17	2,47	1,88	1,38	0,96	0,59		
0,19	37,60	29,52	24,15	20,04	17,25	14,82	13,10	10,67	8,49	6,78	5,41	4,31	3,41	2,66	2,03	1,49	1,03	0,64		
0,20	39,28	30,78	25,00	20,90	17,98	15,55	13,55	11,40	9,05	7,24	5,79	4,61	3,64	2,84	2,17	1,60	1,11	0,69		

Maximum values of the variable load Q (kN/m²), $\psi_2=0,60$

Steel sheet thickness: $t=0,80\text{mm}$, Concrete: C20/25, Steel reinforcement: B500C **Fire resistance: 90 minutes**

Plate thickness	Span L (m)																			
h_f (m)	1,00	1,25	1,50	1,75	2,00	2,25	2,50	2,75	3,00	3,25	3,50	3,75	4,00	4,25	4,50	4,75	5,00	5,25	5,50	
0,13	24,06	18,97	15,40	11,67	8,54	6,38	4,83	3,68	2,81	2,12	1,58	1,14	0,77							
0,14	25,82	20,17	16,55	12,95	9,51	7,11	5,39	4,11	3,13	2,37	1,76	1,27	0,87	0,53						
0,15	27,55	21,55	17,55	14,30	10,49	7,84	5,94	4,53	3,45	2,61	1,94	1,40	0,96	0,59						
0,16	29,16	22,72	18,50	15,55	11,47	8,57	6,50	4,95	3,78	2,86	2,13	1,54	1,05	0,64						
0,17	30,64	23,86	19,45	16,30	12,45	9,31	7,05	5,38	4,10	3,10	2,31	1,67	1,14	0,70						
0,18	32,10	25,08	20,40	17,10	13,40	10,04	7,61	5,80	4,43	3,35	2,49	1,80	1,23	0,76						
0,19	33,63	26,28	21,35	17,80	14,35	10,77	8,16	6,23	4,75	3,60	2,68	1,93	1,32	0,82						
0,20	35,14	27,36	22,20	18,45	15,35	11,50	8,72	6,65	5,07	3,84	2,86	2,07	1,42	0,87						

Maximum values of the variable load Q (kN/m²), $\psi_2=0,60$

Steel sheet thickness: $t=1,00\text{mm}$, Concrete: C20/25, Steel reinforcement: B500C **Fire resistance: 90 minutes**

Plate thickness	Span L (m)																			
h_f (m)	1,00	1,25	1,50	1,75	2,00	2,25	2,50	2,75	3,00	3,25	3,50	3,75	4,00	4,25	4,50	4,75	5,00	5,25	5,50	
0,13	26,24	20,51	16,80	14,12	11,02	8,40	6,47	5,03	3,94	3,08	2,40	1,85	1,40	1,03	0,71					
0,14	28,09	21,98	18,00	15,10	12,35	9,37	7,21	5,61	4,39	3,44	2,68	2,07	1,57	1,15	0,80	0,50				
0,15	29,91	23,45	19,05	16,05	13,53	10,33	7,96	6,19	4,85	3,80	2,96	2,29	1,73	1,27	0,89	0,56				
0,16	31,51	24,63	20,15	16,95	14,46	11,30	8,70	6,77	5,30	4,16	3,24	2,50	1,90	1,40	0,97	0,61				
0,17	33,28	25,96	21,25	17,70	15,20	12,25	9,45	7,35	5,76	4,51	3,52	2,72	2,06	1,52	1,06	0,67				
0,18	34,93	27,18	22,25	18,60	15,90	13,09	10,19	7,93	6,21	4,87	3,80	2,94	2,23	1,64	1,15	0,73				
0,19	36,25	28,57	23,15	19,45	16,59	14,05	10,95	8,51	6,67	5,23	4,08	3,16	2,40	1,76	1,23	0,78				
0,20	37,94	29,74	24,05	20,22	17,18	14,94	11,65	9,09	7,12	5,59	4,36	3,37	2,56	1,89	1,32	0,84				

Maximum values of the variable load Q (kN/m²), $\psi_2=0,60$

Steel sheet thickness: $t=1,25\text{mm}$, Concrete: C20/25, Steel reinforcement: B500C **Fire resistance: 90 minutes**

Plate thickness	Span L (m)																			
h_f (m)	1,00	1,25	1,50	1,75	2,00	2,25	2,50	2,75	3,00	3,25	3,50	3,75	4,00	4,25	4,50	4,75	5,00	5,25	5,50	
0,13	28,46	22,36	18,29	15,39	13,20	10,85	8,45	6,65	5,30	4,25	3,40	2,72	2,15	1,70	1,31	0,98	0,70			
0,14	30,48	23,93	19,58	16,46	14,10	12,10	9,41	7,43	5,92	4,74	3,80	3,02	2,42	1,90	1,47	1,10	0,78			
0,15	32,45	25,45	20,67	17,45	14,95	12,95	10,32	8,20	6,53	5,23	4,20	3,36	2,67	2,10	1,62	1,21	0,87	0,57		
0,16	34,08	26,90	21,89	18,40	15,80	13,75	11,35	8,97	7,14	5,72	4,59	3,67	2,92	2,30	1,78	1,33	0,95	0,63		
0,17	35,84	28,25	23,08	19,25	16,50	14,45	12,30	9,67	7,76	6,21	4,99	4,00	3,18	2,50	1,94	1,45	1,04	0,69		
0,18	37,67	29,70	24,25	20,30	17,25	15,10	13,25	10,45	8,37	6,71	5,38	4,31	3,43	2,71	2,09	1,57	1,13	0,75		
0,19	39,36	30,95	25,30	21,20	18,00	15,65	13,80	11,25	8,99	7,20	5,78	4,63	3,69	2,91	2,25	1,69	1,22	0,81		
0,20	40,96	32,22	26,27	22,10	18,88	16,20	14,25	12,02	9,57	7,69	6,18	4,95	3,95	3,11	2,41	1,81	1,30	0,87		

Maximum values of the variable load Q (kN/m²), $\psi_2=0,60$

□ Without additional reinforcement. □ 1ø6 □ 1ø8 □ 1ø10 □ 1ø12 □ 1ø14

Fire dimensional sizing boards Symdeck 73

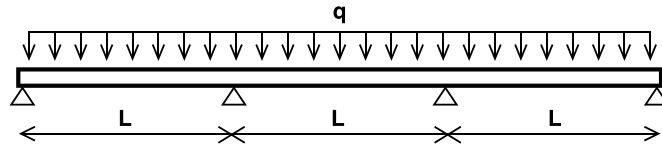

Reinforcement in positions of bending moments

h_i (m)	0,13	0,14	0,15	0,16	0,17	0,18	0,19	0,20
Diameter (mm) / Space (mm)	Ø8/200	Ø8/200	Ø8/150	Ø8/150	Ø10/200	Ø10/200	Ø10/150	Ø10/150

Steel sheet thickness: $t=0,75\text{mm}$, Concrete: C20/25, Steel reinforcement: B500C

Fire resistance: 120 minutes

Plate thickness	Span L (m)																			
h_i (m)	1,00	1,25	1,50	1,75	2,00	2,25	2,50	2,75	3,00	3,25	3,50	3,75	4,00	4,25	4,50	4,75	5,00	5,25	5,50	
0,13	27,24	21,39	17,48	14,60	12,60	9,95	7,67	5,99	4,71	3,71	2,92	2,28	1,76	1,32	0,96					
0,14	29,10	22,89	18,70	15,71	13,46	11,20	8,69	6,79	5,34	4,22	3,33	2,61	2,02	1,53	1,12	0,69				
0,15	30,80	24,14	19,84	16,68	14,28	12,36	9,71	7,59	5,98	4,73	3,73	2,93	2,27	1,73	1,27	0,74	0,23			
0,16	32,57	25,73	20,91	17,59	15,05	13,10	10,70	8,39	6,62	5,24	4,14	3,26	2,53	1,93	1,43	0,78	0,22			
0,17	34,26	27,05	21,96	18,39	15,77	13,75	11,65	9,16	7,33	5,85	4,67	3,72	2,93	2,29	1,52	0,82	0,22			
0,18	35,95	28,15	23,15	19,27	16,55	14,25	12,55	9,92	7,91	6,31	5,04	4,01	3,17	2,47	1,62	0,86	0,22			
0,19	37,60	29,52	24,15	20,04	17,25	14,82	13,10	10,67	8,49	6,78	5,41	4,31	3,41	2,66	1,71	0,90	0,21			
0,20	39,28	30,78	25,00	20,90	17,98	15,55	13,55	11,40	9,05	7,24	5,79	4,61	3,64	2,82	1,81	0,95	0,21			

Maximum values of the variable load Q (kN/m²), $\psi_2=0,60$

Steel sheet thickness: $t=0,80\text{mm}$, Concrete: C20/25, Steel reinforcement: B500C

Fire resistance: 120 minutes

Plate thickness	Span L (m)																			
h_i (m)	1,00	1,25	1,50	1,75	2,00	2,25	2,50	2,75	3,00	3,25	3,50	3,75	4,00	4,25	4,50	4,75	5,00	5,25	5,50	
0,13	24,06	18,97	15,40	11,67	8,54	6,98	4,83	3,68	2,81	2,12	1,58	1,14	0,77							
0,14	25,82	20,17	16,55	12,95	9,51	7,11	5,39	4,11	3,13	2,37	1,76	1,27	0,87	0,53						
0,15	27,55	21,55	17,55	14,30	10,49	7,84	5,94	4,53	3,45	2,61	1,94	1,40	0,96	0,59						
0,16	29,16	22,72	18,50	15,55	11,47	8,57	6,50	4,95	3,78	2,86	2,13	1,54	1,05	0,64						
0,17	30,64	23,86	19,45	16,30	12,45	9,31	7,05	5,38	4,10	3,10	2,31	1,67	1,14	0,70						
0,18	32,10	25,08	20,40	17,10	13,40	10,04	7,61	5,80	4,43	3,35	2,49	1,80	1,23	0,76						
0,19	33,63	26,28	21,35	17,80	14,35	10,77	8,16	6,23	4,75	3,60	2,68	1,93	1,32	0,82						
0,20	35,14	27,36	22,20	18,45	15,35	11,50	8,72	6,65	5,07	3,84	2,86	2,07	1,42	0,87						

Maximum values of the variable load Q (kN/m²), $\psi_2=0,60$

Steel sheet thickness: $t=1,00\text{mm}$, Concrete: C20/25, Steel reinforcement: B500C

Fire resistance: 120 minutes

Plate thickness	Span L (m)																			
h_i (m)	1,00	1,25	1,50	1,75	2,00	2,25	2,50	2,75	3,00	3,25	3,50	3,75	4,00	4,25	4,50	4,75	5,00	5,25	5,50	
0,13	26,24	20,51	16,80	14,12	11,92	8,40	6,47	5,03	3,94	3,08	2,40	1,85	1,40	1,03	0,71					
0,14	28,09	21,98	18,00	15,10	12,35	9,37	7,21	5,61	4,39	3,44	2,68	2,07	1,57	1,15	0,80	0,50				
0,15	29,91	23,45	19,05	16,05	13,53	10,33	7,96	6,19	4,85	3,80	2,96	2,29	1,73	1,27	0,89	0,56				
0,16	31,51	24,63	20,15	16,95	14,46	11,30	8,70	6,77	5,30	4,16	3,24	2,50	1,90	1,40	0,97	0,61				
0,17	33,28	25,96	21,25	17,70	15,20	12,25	9,45	7,35	5,76	4,51	3,52	2,72	2,06	1,52	1,06	0,67				
0,18	34,93	27,18	22,25	18,60	15,90	13,09	10,19	7,93	6,21	4,87	3,80	2,94	2,23	1,64	1,15	0,73				
0,19	36,25	28,57	23,15	19,45	16,59	14,05	10,95	8,51	6,67	5,23	4,08	3,16	2,40	1,76	1,23	0,78				
0,20	37,94	29,74	24,05	20,22	17,18	14,94	11,65	9,09	7,12	5,59	4,36	3,37	2,56	1,89	1,32	0,84				

Maximum values of the variable load Q (kN/m²), $\psi_2=0,60$

Steel sheet thickness: $t=1,25\text{mm}$, Concrete: C20/25, Steel reinforcement: B500C

Fire resistance: 120 minutes

Plate thickness	Span L (m)																			
h_i (m)	1,00	1,25	1,50	1,75	2,00	2,25	2,50	2,75	3,00	3,25	3,50	3,75	4,00	4,25	4,50	4,75	5,00	5,25	5,50	
0,13	28,46	22,36	18,29	15,39	13,20	10,85	8,45	6,65	5,30	4,25	3,40	2,72	2,15	1,70	1,31	0,98	0,70			
0,14	30,48	23,93	19,58	16,46	14,10	12,10	9,41	7,43	5,92	4,74	3,80	3,02	2,42	1,90	1,47	1,10	0,78			
0,15	32,45	25,45	20,67	17,45	14,95	12,95	10,32	8,20	6,53	5,23	4,20	3,36	2,67	2,10	1,62	1,21	0,87	0,40		
0,16	34,08	26,90	21,89	18,40	15,80	13,75	11,35	8,97	7,14	5,72	4,59	3,67	2,92	2,30	1,78	1,33	0,95	0,43		
0,17	35,84	28,25	23,08	19,25	16,50	14,45	12,30	9,67	7,76	6,21	4,99	4,00	3,18	2,50	1,94	1,45	1,04	0,46		
0,18	37,67	29,70	24,25	20,30	17,25	15,10	13,25	10,45	8,37	6,71	5,38	4,31	3,43	2,71	2,09	1,57	1,13	0,49		
0,19	39,36	30,95	25,30	21,20	18,00	15,65	13,80	11,25	8,99	7,20	5,78	4,63	3,69	2,91	2,25	1,69	1,21	0,52		
0,20	40,96	32,22	26,27	22,10	18,88	16,20	14,25	12,02	9,57	7,69	6,18	4,95	3,95	3,11	2,41	1,81	1,28	0,54		

Maximum values of the variable load Q (kN/m²), $\psi_2=0,60$

1ø14 1ø12 1ø10 1ø8 1ø6 Without additional reinforcement. □

Fire dimensional sizing boards Symdeck 100

In case the slab satisfies the bearing capacity criterion (criterion R) but does not meet the thermal insulation criterion (criterion I) the value of the maximum load is written in the tables and has a sloping line.

The following tables determine the maximum payload useful load Q that the composite plate can carry for three different

static systems, for a range of openings from 1,00 m to 5,50 m and for a coefficient value $\psi_2=0,60$.

The tables are differentiated according to the fire resistance (the cases are R30, R60, R90, and R120).

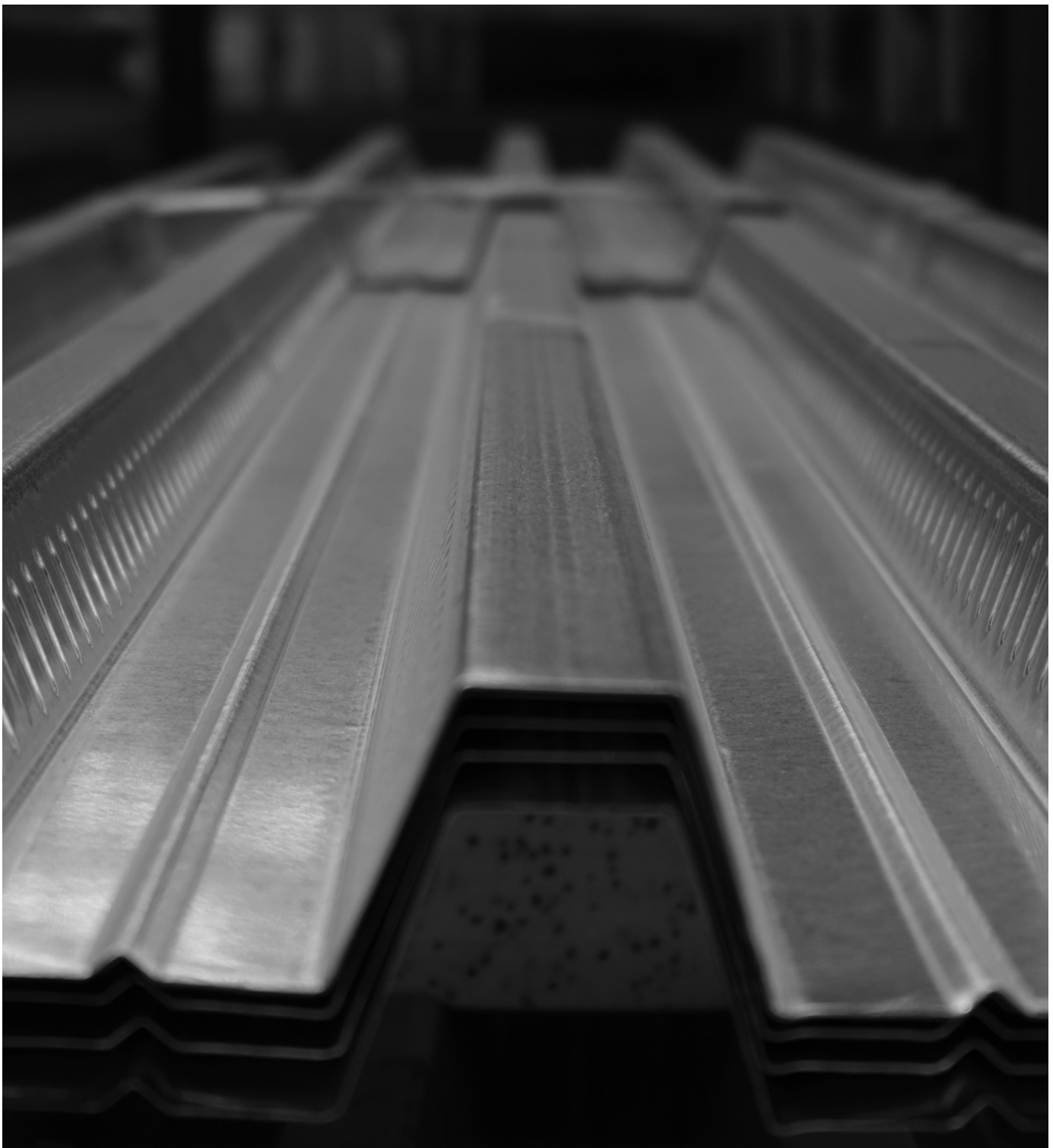

Fire dimensional sizing boards Symdeck 100

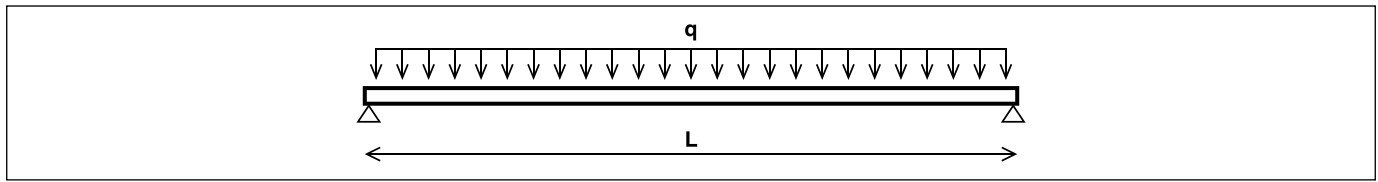

Steel sheet thickness: t=0,75mm

Fire resistance: 30 minutes

Plate thickness	Span L (m)																		
h (m)	1,00	1,25	1,50	1,75	2,00	2,25	2,50	2,75	3,00	3,25	3,50	3,75	4,00	4,25	4,50	4,75	5,00	5,25	5,50
0,15	37,80	24,05	16,01	11,16	8,00	5,84	4,29	3,14	2,27	1,59	1,05	0,61							
0,16	40,08	26,35	17,54	12,23	8,77	6,40	4,70	3,44	2,49	1,74	1,15	0,67							
0,17	42,30	28,65	19,07	13,29	9,54	6,96	5,11	3,75	2,71	1,90	1,25	0,73							
0,18	44,46	30,94	20,60	14,36	10,30	7,52	5,53	4,05	2,93	2,05	1,35	0,79							
0,19	46,55	33,24	22,13	15,42	11,07	8,08	5,94	4,35	3,14	2,20	1,46	0,85							
0,20	48,59	35,53	23,66	16,49	11,83	8,64	6,35	4,65	3,36	2,36	1,56	0,91							
0,21	50,59	37,83	25,19	17,56	12,60	9,20	6,76	4,96	3,58	2,51	1,66	0,98							
0,22	52,54	40,12	26,72	18,62	13,37	9,76	7,17	5,26	3,80	2,67	1,77	1,04							

Steel sheet thickness: t=1,00mm

Fire resistance: 30 minutes

Plate thickness	Span L (m)																		
h (m)	1,00	1,25	1,50	1,75	2,00	2,25	2,50	2,75	3,00	3,25	3,50	3,75	4,00	4,25	4,50	4,75	5,00	5,25	5,50
0,15	41,74	32,67	21,97	15,51	11,31	8,43	6,37	4,85	3,69	2,78	2,06	1,48	1,01	0,61	0,28				
0,16	44,29	34,89	24,07	17,00	12,40	9,25	6,99	5,32	4,05	3,06	2,27	1,64	1,12	0,68	0,32				
0,17	46,75	36,81	26,18	18,49	13,49	10,07	7,61	5,80	4,41	3,34	2,48	1,79	1,22	0,75	0,36				
0,18	49,14	38,68	28,29	19,98	14,58	10,88	8,23	6,27	4,78	3,61	2,69	1,94	1,33	0,82	0,40				
0,19	51,47	40,50	30,39	21,47	15,67	11,70	8,85	6,74	5,14	3,89	2,90	2,10	1,44	0,90	0,44				
0,20	53,74	42,27	32,50	22,96	16,76	12,51	9,47	7,22	5,50	4,17	3,11	2,25	1,55	0,97	0,48				
0,21	55,96	44,00	34,60	24,45	17,86	13,33	10,09	7,69	5,87	4,44	3,31	2,40	1,66	1,04	0,52				
0,22	58,13	45,69	36,71	25,94	18,95	14,15	10,71	8,17	6,23	4,72	3,52	2,56	1,76	1,11	0,56				

Steel sheet thickness: t=1,25mm

Fire resistance: 30 minutes

Plate thickness	Span L (m)																		
h (m)	1,00	1,25	1,50	1,75	2,00	2,25	2,50	2,75	3,00	3,25	3,50	3,75	4,00	4,25	4,50	4,75	5,00	5,25	5,50
0,15	45,07	35,54	27,92	19,86	14,62	11,03	8,46	6,55	5,10	3,98	3,08	2,36	1,76	1,27	0,86				
0,16	47,82	37,70	30,61	21,77	16,04	12,10	9,28	7,20	5,61	4,38	3,39	2,60	1,95	1,41	0,96				
0,17	50,49	39,79	32,65	23,69	17,45	13,17	10,11	7,84	6,12	4,78	3,71	2,85	2,14	1,56	1,07				
0,18	53,09	41,82	34,31	25,60	18,87	14,25	10,94	8,49	6,63	5,18	4,02	3,09	2,33	1,70	1,17				
0,19	55,61	43,79	35,92	27,52	20,28	15,32	11,77	9,14	7,13	5,58	4,34	3,34	2,52	1,84	1,27				
0,20	58,08	45,72	37,48	29,43	21,70	16,39	12,59	9,78	7,64	5,98	4,65	3,58	2,71	1,98	1,38				
0,21	60,48	47,60	39,01	31,34	23,11	17,46	13,42	10,43	8,15	6,38	4,97	3,83	2,90	2,13	1,48				
0,22	62,84	49,44	40,50	33,26	24,53	18,53	14,25	11,07	8,66	6,78	5,28	4,08	3,09	2,27	1,58				

Steel sheet thickness: t=1,50mm

Fire resistance: 30 minutes

Plate thickness	Span L (m)																		
h (m)	1,00	1,25	1,50	1,75	2,00	2,25	2,50	2,75	3,00	3,25	3,50	3,75	4,00	4,25	4,50	4,75	5,00	5,25	5,50
0,15	46,40	36,59	30,05	24,23	17,95	13,64	10,56	8,27	6,54	5,19	4,11	3,24	2,54	1,95	1,45	1,04	0,68	0,37	0,10
0,16	50,85	40,11	32,94	26,56	19,69	14,97	11,59	9,09	7,19	5,71	4,53	3,58	2,81	2,16	1,62	1,16	0,77	0,44	0,14
0,17	53,77	42,39	34,81	28,90	21,42	16,30	12,63	9,91	7,84	6,23	4,95	3,92	3,08	2,38	1,79	1,29	0,87	0,50	0,18
0,18	56,54	44,56	36,58	30,88	23,16	17,62	13,66	10,73	8,49	6,75	5,37	4,26	3,35	2,59	1,95	1,42	0,96	0,56	0,22
0,19	59,24	46,68	38,30	32,32	24,90	18,95	14,69	11,54	9,14	7,28	5,79	4,60	3,62	2,80	2,12	1,54	1,05	0,63	0,26
0,20	61,87	48,74	39,98	33,73	26,64	20,28	15,73	12,36	9,80	7,80	6,21	4,93	3,89	3,02	2,29	1,67	1,15	0,69	0,30
0,21	64,44	50,75	41,62	35,10	28,38	21,61	16,76	13,18	10,45	8,32	6,63	5,27	4,16	3,23	2,46	1,80	1,24	0,76	0,34
0,22	66,95	52,72	43,22	36,44	30,12	22,94	17,80	13,99	11,10	8,84	7,05	5,61	4,43	3,45	2,62	1,93	1,33	0,82	0,38

Fire dimensional sizing boards Symdeck 100

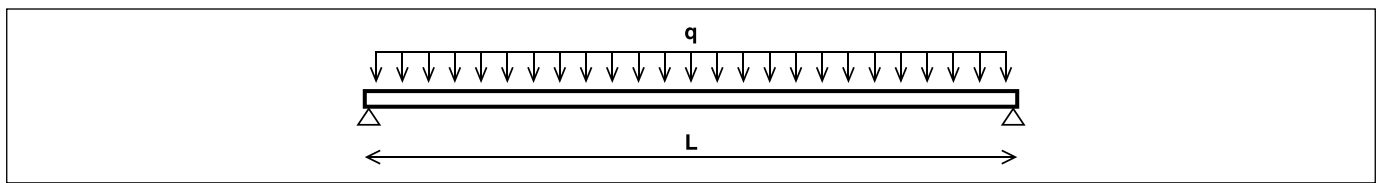

Steel sheet thickness: $t=0,75\text{mm}$

Fire resistance: 60 minutes

Plate thickness	Span L (m)																		
h (m)	1,00	1,25	1,50	1,75	2,00	2,25	2,50	2,75	3,00	3,25	3,50	3,75	4,00	4,25	4,50	4,75	5,00	5,25	5,50
0,15	37,80	24,05	16,01	11,16	8,00	5,84	4,29	3,14	2,27	1,59	1,05	0,61							
0,16	40,08	26,35	17,54	12,23	8,77	6,40	4,70	3,44	2,49	1,74	1,15	0,67							
0,17	42,30	28,65	19,07	13,29	9,54	6,96	5,11	3,75	2,71	1,90	1,25	0,73							
0,18	44,46	30,94	20,60	14,36	10,30	7,52	5,53	4,05	2,93	2,05	1,35	0,79							
0,19	46,55	33,24	22,13	15,42	11,07	8,08	5,94	4,35	3,14	2,20	1,46	0,85							
0,20	48,59	35,53	23,66	16,49	11,83	8,64	6,35	4,65	3,36	2,36	1,56	0,91							
0,21	50,59	37,83	25,19	17,56	12,60	9,20	6,76	4,96	3,58	2,51	1,66	0,98							
0,22	52,54	40,12	26,72	18,62	13,37	9,76	7,17	5,26	3,80	2,67	1,77	1,04							

Steel sheet thickness: $t=1,00\text{mm}$

Fire resistance: 60 minutes

Plate thickness	Span L (m)																		
h (m)	1,00	1,25	1,50	1,75	2,00	2,25	2,50	2,75	3,00	3,25	3,50	3,75	4,00	4,25	4,50	4,75	5,00	5,25	5,50
0,15	41,74	32,67	21,97	15,51	11,31	8,43	6,37	4,85	3,69	2,78	2,06	1,48	1,01	0,61	0,28				
0,16	44,29	34,89	24,07	17,00	12,40	9,25	6,99	5,32	4,05	3,06	2,27	1,64	1,12	0,68	0,32				
0,17	46,75	36,81	26,18	18,49	13,49	10,07	7,61	5,80	4,41	3,34	2,48	1,79	1,22	0,75	0,36				
0,18	49,14	38,68	28,29	19,98	14,58	10,88	8,23	6,27	4,78	3,61	2,69	1,94	1,33	0,82	0,40				
0,19	51,47	40,50	30,39	21,47	15,67	11,70	8,85	6,74	5,14	3,89	2,90	2,10	1,44	0,90	0,44				
0,20	53,74	42,27	32,50	22,96	16,76	12,51	9,47	7,22	5,50	4,17	3,11	2,25	1,55	0,97	0,48				
0,21	55,96	44,00	34,60	24,45	17,86	13,33	10,09	7,69	5,87	4,44	3,31	2,40	1,66	1,04	0,52				
0,22	58,13	45,69	36,71	25,94	18,95	14,15	10,71	8,17	6,23	4,72	3,52	2,56	1,76	1,11	0,56				

Steel sheet thickness: $t=1,25\text{mm}$

Fire resistance: 60 minutes

Plate thickness	Span L (m)																		
h (m)	1,00	1,25	1,50	1,75	2,00	2,25	2,50	2,75	3,00	3,25	3,50	3,75	4,00	4,25	4,50	4,75	5,00	5,25	5,50
0,15	45,07	35,54	27,92	19,86	14,62	11,03	8,46	6,55	5,10	3,98	3,08	2,36	1,76	1,27	0,86				
0,16	47,82	37,70	30,61	21,77	16,04	12,10	9,28	7,20	5,61	4,38	3,39	2,60	1,95	1,41	0,96				
0,17	50,49	39,79	32,65	23,69	17,45	13,17	10,11	7,84	6,12	4,78	3,71	2,85	2,14	1,56	1,07				
0,18	53,09	41,82	34,31	25,60	18,87	14,25	10,94	8,49	6,63	5,18	4,02	3,09	2,33	1,70	1,17				
0,19	55,61	43,79	35,92	27,52	20,28	15,32	11,77	9,14	7,13	5,58	4,34	3,34	2,52	1,84	1,27				
0,20	58,08	45,72	37,48	29,43	21,70	16,39	12,59	9,78	7,64	5,98	4,65	3,58	2,71	1,98	1,38				
0,21	60,48	47,60	39,01	31,34	23,11	17,46	13,42	10,43	8,15	6,38	4,97	3,83	2,90	2,13	1,48				
0,22	62,84	49,44	40,50	33,26	24,53	18,53	14,25	11,07	8,66	6,78	5,28	4,08	3,09	2,27	1,58				

Steel sheet thickness: $t=1,50\text{mm}$

Fire resistance: 60 minutes

Plate thickness	Span L (m)																		
h (m)	1,00	1,25	1,50	1,75	2,00	2,25	2,50	2,75	3,00	3,25	3,50	3,75	4,00	4,25	4,50	4,75	5,00	5,25	5,50
0,15	46,40	36,59	30,05	24,23	17,95	13,64	10,56	8,27	6,54	5,19	4,11	3,24	2,54	1,95	1,45	1,04	0,68	0,37	0,10
0,16	50,85	40,11	32,94	26,56	19,69	14,97	11,59	9,09	7,19	5,71	4,53	3,58	2,81	2,16	1,62	1,16	0,77	0,44	0,14
0,17	53,77	42,39	34,81	28,90	21,42	16,30	12,63	9,91	7,84	6,23	4,95	3,92	3,08	2,38	1,79	1,29	0,87	0,50	0,18
0,18	56,54	44,56	36,58	30,88	23,16	17,62	13,66	10,73	8,49	6,75	5,37	4,26	3,35	2,59	1,95	1,42	0,96	0,56	0,22
0,19	59,24	46,68	38,30	32,32	24,90	18,95	14,69	11,54	9,14	7,28	5,79	4,60	3,62	2,80	2,12	1,54	1,05	0,63	0,26
0,20	61,87	48,74	39,98	33,73	26,64	20,28	15,73	12,36	9,80	7,80	6,21	4,93	3,89	3,02	2,29	1,67	1,15	0,69	0,30
0,21	64,44	50,75	41,62	35,10	28,38	21,61	16,76	13,18	10,45	8,32	6,63	5,27	4,16	3,23	2,46	1,80	1,24	0,76	0,34
0,22	66,95	52,72	43,22	36,44	30,12	22,94	17,80	13,99	11,10	8,84	7,05	5,61	4,43	3,45	2,62	1,93	1,33	0,82	0,38

Without additional reinforcement.
 1ø6
 1ø8
 1ø10
 1ø12
 1ø14

Fire dimensional sizing boards Symdeck 100

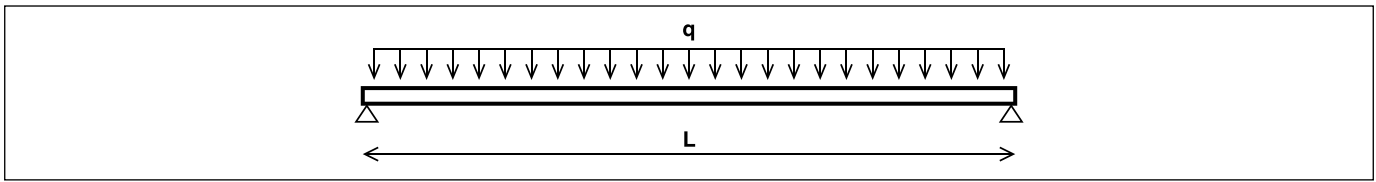

Steel sheet thickness: **t=0,75mm**

Fire resistance: **90 minutes**

Plate thickness	Span L (m)																		
h (m)	1,00	1,25	1,50	1,75	2,00	2,25	2,50	2,75	3,00	3,25	3,50	3,75	4,00	4,25	4,50	4,75	5,00	5,25	5,50
0,15	37,80	24,05	16,01	11,16	8,00	5,84	4,29	3,14	2,27	1,59	1,05	0,61							
0,16	40,08	26,35	17,54	12,23	8,77	6,40	4,70	3,44	2,49	1,74	1,15	0,67							
0,17	42,30	28,65	19,07	13,29	9,54	6,96	5,11	3,75	2,71	1,90	1,25	0,73							
0,18	44,46	30,94	20,60	14,36	10,30	7,52	5,53	4,05	2,93	2,05	1,35	0,79							
0,19	46,55	33,24	22,13	15,42	11,07	8,08	5,94	4,35	3,14	2,20	1,46	0,85							
0,20	48,59	35,53	23,66	16,49	11,83	8,64	6,35	4,65	3,36	2,36	1,56	0,91							
0,21	50,59	37,83	25,19	17,56	12,60	9,20	6,76	4,96	3,58	2,51	1,66	0,98							
0,22	52,54	40,12	26,72	18,62	13,37	9,76	7,17	5,26	3,80	2,67	1,77	1,04							

Steel sheet thickness: **t=1,00mm**

Fire resistance: **90 minutes**

Plate thickness	Span L (m)																		
h (m)	1,00	1,25	1,50	1,75	2,00	2,25	2,50	2,75	3,00	3,25	3,50	3,75	4,00	4,25	4,50	4,75	5,00	5,25	5,50
0,15	41,74	32,67	21,97	15,51	11,31	8,43	6,37	4,85	3,69	2,78	2,06	1,48	1,01	0,61	0,28				
0,16	44,29	34,89	24,07	17,00	12,40	9,25	6,99	5,32	4,05	3,06	2,27	1,64	1,12	0,68	0,32				
0,17	46,75	36,81	26,18	18,49	13,49	10,07	7,61	5,80	4,41	3,34	2,48	1,79	1,22	0,75	0,36				
0,18	49,14	38,68	28,29	19,98	14,58	10,88	8,23	6,27	4,78	3,61	2,69	1,94	1,33	0,82	0,40				
0,19	51,47	40,50	30,39	21,47	15,67	11,70	8,85	6,74	5,14	3,89	2,90	2,10	1,44	0,90	0,44				
0,20	53,74	42,27	32,50	22,96	16,76	12,51	9,47	7,22	5,50	4,17	3,11	2,25	1,55	0,97	0,48				
0,21	55,96	44,00	34,60	24,45	17,86	13,33	10,09	7,69	5,87	4,44	3,31	2,40	1,66	1,04	0,52				
0,22	58,13	45,69	36,71	25,94	18,95	14,15	10,71	8,17	6,23	4,72	3,52	2,56	1,76	1,11	0,56				

Steel sheet thickness: **t=1,25mm**

Fire resistance: **90 minutes**

Plate thickness	Span L (m)																		
h (m)	1,00	1,25	1,50	1,75	2,00	2,25	2,50	2,75	3,00	3,25	3,50	3,75	4,00	4,25	4,50	4,75	5,00	5,25	5,50
0,15	45,07	35,54	27,92	19,86	14,62	11,03	8,46	6,55	5,10	3,98	3,08	2,36	1,76	1,27	0,86				
0,16	47,82	37,70	30,61	21,77	16,04	12,10	9,28	7,20	5,61	4,38	3,39	2,60	1,95	1,41	0,96				
0,17	50,49	39,79	32,65	23,69	17,45	13,17	10,11	7,84	6,12	4,78	3,71	2,85	2,14	1,56	1,07				
0,18	53,09	41,82	34,31	25,60	18,87	14,25	10,94	8,49	6,63	5,18	4,02	3,09	2,33	1,70	1,17				
0,19	55,61	43,79	35,92	27,52	20,28	15,32	11,77	9,14	7,13	5,58	4,34	3,34	2,52	1,84	1,27				
0,20	58,08	45,72	37,48	29,43	21,70	16,39	12,59	9,78	7,64	5,98	4,65	3,58	2,71	1,98	1,38				
0,21	60,48	47,60	39,01	31,34	23,11	17,46	13,42	10,43	8,15	6,38	4,97	3,83	2,90	2,13	1,48				
0,22	62,84	49,44	40,50	33,26	24,53	18,53	14,25	11,07	8,66	6,78	5,28	4,08	3,09	2,27	1,58				

Steel sheet thickness: **t=1,50mm**

Fire resistance: **90 minutes**

Plate thickness	Span L (m)																		
h (m)	1,00	1,25	1,50	1,75	2,00	2,25	2,50	2,75	3,00	3,25	3,50	3,75	4,00	4,25	4,50	4,75	5,00	5,25	5,50
0,15	46,40	36,59	30,05	24,23	17,95	13,64	10,56	8,27	6,54	5,19	4,11	3,24	2,54	1,95	1,45	1,04	0,68	0,37	0,10
0,16	50,85	40,11	32,94	26,56	19,69	14,97	11,59	9,09	7,19	5,71	4,53	3,58	2,81	2,16	1,62	1,16	0,77	0,44	0,14
0,17	53,77	42,39	34,81	28,90	21,42	16,30	12,63	9,91	7,84	6,23	4,95	3,92	3,08	2,38	1,79	1,29	0,87	0,50	0,18
0,18	56,54	44,56	36,58	30,88	23,16	17,62	13,66	10,73	8,49	6,75	5,37	4,26	3,35	2,59	1,95	1,42	0,96	0,56	0,22
0,19	59,24	46,68	38,30	32,32	24,90	18,95	14,69	11,54	9,14	7,28	5,79	4,60	3,62	2,80	2,12	1,54	1,05	0,63	0,26
0,20	61,87	48,74	39,98	33,73	26,64	20,28	15,73	12,36	9,80	7,80	6,21	4,93	3,89	3,02	2,29	1,67	1,15	0,69	0,30
0,21	64,44	50,75	41,62	35,10	28,38	21,61	16,76	13,18	10,45	8,32	6,63	5,27	4,16	3,23	2,46	1,80	1,24	0,76	0,34
0,22	66,95	52,72	43,22	36,44	30,12	22,94	17,80	13,99	11,10	8,84	7,05	5,61	4,43	3,45	2,62	1,93	1,33	0,82	0,38

Fire dimensional sizing boards Symdeck 100

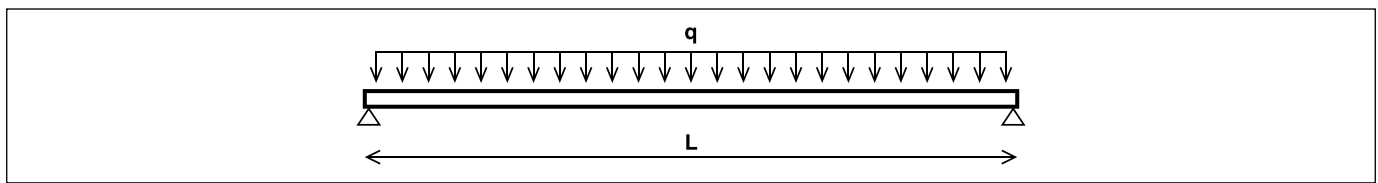

Steel sheet thickness: $t=0,75\text{mm}$

Fire resistance: 120 minutes

Plate thickness	Span L (m)																		
h (m)	1,00	1,25	1,50	1,75	2,00	2,25	2,50	2,75	3,00	3,25	3,50	3,75	4,00	4,25	4,50	4,75	5,00	5,25	5,50
0,15	37,80	24,05	18,01	11,16	8,90	5,84	4,29	3,14	2,27	1,59	1,05	0,61							
0,16	40,08	26,35	17,54	12,23	8,77	6,40	4,70	3,44	2,49	1,74	1,15	0,67							
0,17	42,30	28,65	19,07	13,29	9,54	6,96	5,11	3,75	2,71	1,90	1,25	0,73							
0,18	44,46	30,94	20,60	14,36	10,30	7,52	5,53	4,05	2,93	2,05	1,35	0,79							
0,19	46,55	33,24	22,13	15,42	11,07	8,08	5,94	4,35	3,14	2,20	1,46	0,85							
0,20	48,59	35,53	23,66	16,49	11,83	8,64	6,35	4,65	3,36	2,36	1,56	0,91							
0,21	50,59	37,83	25,19	17,56	12,60	9,20	6,76	4,96	3,58	2,51	1,66	0,98							
0,22	52,54	40,12	26,72	18,62	13,37	9,76	7,17	5,26	3,80	2,67	1,77	1,04							

Steel sheet thickness: $t=1,00\text{mm}$

Fire resistance: 120 minutes

Plate thickness	Span L (m)																		
h (m)	1,00	1,25	1,50	1,75	2,00	2,25	2,50	2,75	3,00	3,25	3,50	3,75	4,00	4,25	4,50	4,75	5,00	5,25	5,50
0,15	41,74	32,67	21,97	15,51	11,31	8,43	6,37	4,85	3,69	2,78	2,06	1,48	1,01	0,61	0,28				
0,16	44,29	34,89	24,07	17,00	12,40	9,25	6,99	5,32	4,05	3,06	2,27	1,64	1,12	0,68	0,32				
0,17	46,75	36,81	26,18	18,49	13,49	10,07	7,61	5,80	4,41	3,34	2,48	1,79	1,22	0,75	0,36				
0,18	49,14	38,68	28,29	19,98	14,58	10,88	8,23	6,27	4,78	3,61	2,69	1,94	1,33	0,82	0,40				
0,19	51,47	40,50	30,39	21,47	15,67	11,70	8,85	6,74	5,14	3,89	2,90	2,10	1,44	0,90	0,44				
0,20	53,74	42,27	32,50	22,96	16,76	12,51	9,47	7,22	5,50	4,17	3,11	2,25	1,55	0,97	0,48				
0,21	55,96	44,00	34,60	24,45	17,86	13,33	10,09	7,69	5,87	4,44	3,31	2,40	1,66	1,04	0,52				
0,22	58,13	45,69	36,71	25,94	18,95	14,15	10,71	8,17	6,23	4,72	3,52	2,56	1,76	1,11	0,56				

Steel sheet thickness: $t=1,25\text{mm}$

Fire resistance: 120 minutes

Plate thickness	Span L (m)																		
h (m)	1,00	1,25	1,50	1,75	2,00	2,25	2,50	2,75	3,00	3,25	3,50	3,75	4,00	4,25	4,50	4,75	5,00	5,25	5,50
0,15	45,07	35,54	27,92	19,86	14,62	11,03	8,46	6,55	5,10	3,98	3,08	2,36	1,76	1,27	0,86				
0,16	47,82	37,70	30,61	21,77	16,04	12,10	9,28	7,20	5,61	4,38	3,39	2,60	1,95	1,41	0,96				
0,17	50,49	39,79	32,65	23,69	17,45	13,17	10,11	7,84	6,12	4,78	3,71	2,85	2,14	1,56	1,07				
0,18	53,09	41,82	34,31	25,60	18,87	14,25	10,94	8,49	6,63	5,18	4,02	3,09	2,33	1,70	1,17				
0,19	55,61	43,79	35,92	27,52	20,28	15,32	11,77	9,14	7,13	5,58	4,34	3,34	2,52	1,84	1,27				
0,20	58,08	45,72	37,48	29,43	21,70	16,39	12,59	9,78	7,64	5,98	4,65	3,58	2,71	1,98	1,38				
0,21	60,48	47,60	39,01	31,34	23,11	17,46	13,42	10,43	8,15	6,38	4,97	3,83	2,90	2,13	1,48				
0,22	62,84	49,44	40,50	33,26	24,53	18,53	14,25	11,07	8,66	6,78	5,28	4,08	3,09	2,27	1,58				

Steel sheet thickness: $t=1,50\text{mm}$

Fire resistance: 120 minutes

Plate thickness	Span L (m)																		
h (m)	1,00	1,25	1,50	1,75	2,00	2,25	2,50	2,75	3,00	3,25	3,50	3,75	4,00	4,25	4,50	4,75	5,00	5,25	5,50
0,15	46,40	36,59	30,05	24,23	17,95	13,64	10,56	8,27	6,54	5,19	4,11	3,24	2,54	1,95	1,45	1,04	0,68	0,37	0,10
0,16	50,85	40,11	32,94	26,56	19,69	14,97	11,59	9,09	7,19	5,71	4,53	3,58	2,81	2,16	1,62	1,16	0,77	0,44	0,14
0,17	53,77	42,39	34,81	28,90	21,42	16,30	12,63	9,91	7,84	6,23	4,95	3,92	3,08	2,38	1,79	1,29	0,87	0,50	0,18
0,18	56,54	44,56	36,58	30,88	23,16	17,62	13,66	10,73	8,49	6,75	5,37	4,26	3,35	2,59	1,95	1,42	0,96	0,56	0,22
0,19	59,24	46,68	38,30	32,32	24,90	18,95	14,69	11,54	9,14	7,28	5,79	4,60	3,62	2,80	2,12	1,54	1,05	0,63	0,26
0,20	61,87	48,74	39,98	33,73	26,64	20,28	15,73	12,36	9,80	7,80	6,21	4,93	3,89	3,02	2,29	1,67	1,15	0,69	0,30
0,21	64,44	50,75	41,62	35,10	28,38	21,61	16,76	13,18	10,45	8,32	6,63	5,27	4,16	3,23	2,46	1,80	1,24	0,76	0,34
0,22	66,95	52,72	43,22	36,44	30,12	22,94	17,80	13,99	11,10	8,84	7,05	5,61	4,43	3,45	2,62	1,93	1,33	0,82	0,38

□ Without additional reinforcement. □ 1ø6 □ 1ø8 □ 1ø10 □ 1ø12 □ 1ø14

Fire dimensional sizing boards Symdeck 100

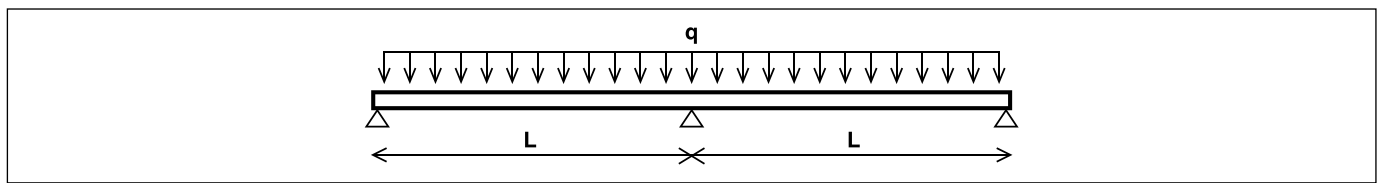

Reinforcement in positions of bending moments								
h (m)	0,15	0,16	0,17	0,18	0,19	0,20	0,21	0,22
Diameter (mm) / Space (mm)	Ø8/125	Ø8/125	Ø10/150	Ø10/150	Ø10/125	Ø10/125	Ø12/150	Ø12/150

Steel sheet thickness: t=0,75mm

Fire resistance: 30 minutes

Plate thickness	Span L (m)																			
h (m)	1,00	1,25	1,50	1,75	2,00	2,25	2,50	2,75	3,00	3,25	3,50	3,75	4,00	4,25	4,50	4,75	5,00	5,25	5,50	
0,15	22,66	17,65	14,31	11,92	9,14	6,74	5,02	3,74	2,77	2,02	1,42	0,93	0,53	0,21						
0,16	24,48	19,06	15,45	12,87	10,01	7,38	5,50	4,10	3,04	2,21	1,55	1,02	0,59	0,23						
0,17	26,33	20,50	16,61	13,83	10,89	8,03	5,98	4,46	3,31	2,41	1,69	1,12	0,64	0,25						
0,18	28,28	22,01	17,83	14,84	11,76	8,67	6,46	4,82	3,57	2,60	1,83	1,21	0,70	0,27						
0,19	30,15	23,46	19,00	15,82	12,64	9,32	6,94	5,18	3,84	2,80	1,97	1,30	0,75	0,30						
0,20	32,15	25,02	20,26	16,86	13,51	9,96	7,42	5,54	4,11	2,99	2,11	1,39	0,81	0,32						
0,21	33,63	26,15	21,17	17,61	14,39	10,61	7,90	5,90	4,38	3,19	2,25	1,48	0,86	0,34						
0,22	35,71	27,78	22,49	18,71	15,26	11,25	8,39	6,26	4,64	3,38	2,38	1,58	0,91	0,36						

Steel sheet thickness: t=1,00mm

Fire resistance: 30 minutes

Plate thickness	Span L (m)																			
h (m)	1,00	1,25	1,50	1,75	2,00	2,25	2,50	2,75	3,00	3,25	3,50	3,75	4,00	4,25	4,50	4,75	5,00	5,25	5,50	
0,15	22,57	17,55	14,21	11,83	10,04	8,65	7,34	5,65	4,36	3,35	2,56	1,91	1,39	0,95	0,58					
0,16	24,39	18,97	15,35	12,77	10,84	9,33	8,05	6,20	4,79	3,69	2,81	2,11	1,53	1,05	0,65					
0,17	26,24	20,40	16,51	13,73	11,65	10,03	8,73	6,75	5,21	4,02	3,07	2,30	1,67	1,15	0,72					
0,18	28,18	21,91	17,73	14,75	12,51	10,77	9,38	7,30	5,64	4,35	3,32	2,50	1,82	1,26	0,78					
0,19	30,06	23,37	18,91	15,72	13,33	11,48	9,99	7,85	6,07	4,68	3,58	2,69	1,96	1,36	0,85					
0,20	32,06	24,92	20,17	16,77	14,22	12,24	10,66	8,40	6,50	5,01	3,84	2,88	2,11	1,46	0,92					
0,21	33,53	26,06	21,08	17,52	14,85	12,77	11,11	8,95	6,92	5,34	4,09	3,08	2,25	1,56	0,99					
0,22	35,62	27,68	22,39	18,61	15,78	13,57	11,81	9,50	7,35	5,68	4,35	3,27	2,39	1,67	1,05					

Steel sheet thickness: t=1,25mm

Fire resistance: 30 minutes

Plate thickness	Span L (m)																			
h (m)	1,00	1,25	1,50	1,75	2,00	2,25	2,50	2,75	3,00	3,25	3,50	3,75	4,00	4,25	4,50	4,75	5,00	5,25	5,50	
0,15	22,47	17,46	14,12	11,73	9,94	8,55	7,44	6,53	5,77	4,69	3,70	2,89	2,24	1,69	1,23	0,85	0,52			
0,16	24,29	18,87	15,26	12,68	10,74	9,24	8,03	7,05	6,23	5,16	4,07	3,19	2,47	1,87	1,37	0,95	0,59			
0,17	26,14	20,31	16,42	13,64	11,56	9,93	8,64	7,58	6,69	5,63	4,44	3,49	2,71	2,06	1,51	1,05	0,66			
0,18	28,09	21,82	17,64	14,65	12,42	10,67	9,28	8,14	7,19	6,10	4,82	3,79	2,94	2,24	1,65	1,15	0,73			
0,19	29,96	23,27	18,81	15,63	13,24	11,38	9,90	8,68	7,67	6,57	5,19	4,08	3,17	2,42	1,79	1,25	0,80			
0,20	31,96	24,83	20,07	16,68	14,13	12,15	10,56	9,26	8,18	7,03	5,56	4,38	3,41	2,60	1,93	1,36	0,87			
0,21	33,44	25,97	20,98	17,42	14,75	12,68	11,02	9,66	8,53	7,50	5,94	4,68	3,64	2,79	2,07	1,46	0,94			
0,22	35,52	27,59	22,30	18,52	15,68	13,48	11,72	10,27	9,07	7,97	6,31	4,97	3,88	2,97	2,21	1,56	1,01			

Steel sheet thickness: t=1,50mm

Fire resistance: 30 minutes

Plate thickness	Span L (m)																			
h (m)	1,00	1,25	1,50	1,75	2,00	2,25	2,50	2,75	3,00	3,25	3,50	3,75	4,00	4,25	4,50	4,75	5,00	5,25	5,50	
0,15	22,39	17,38	14,04	11,65	9,87	8,47	7,36	6,45	5,69	5,05	4,50	3,89	3,10	2,45	1,90	1,44	1,04	0,70		
0,16	24,22	18,80	15,18	12,60	10,66	9,16	7,95	6,97	6,15	5,45	4,86	4,29	3,43	2,71	2,11	1,60	1,17	0,80		
0,17	26,06	20,23	16,34	13,56	11,48	9,86	8,56	7,50	6,61	5,87	5,22	4,67	3,75	2,97	2,32	1,77	1,30	0,89		
0,18	28,01	21,74	17,56	14,58	12,34	10,60	9,20	8,06	7,11	6,31	5,62	5,02	4,08	3,24	2,53	1,94	1,43	0,99		
0,19	29,88	23,19	18,74	15,55	13,16	11,30	9,82	8,60	7,59	6,73	5,99	5,36	4,40	3,50	2,74	2,10	1,55	1,08		
0,20	31,88	24,75	19,99	16,60	14,05	12,07	10,48	9,18	8,10	7,19	6,41	5,73	4,72	3,76	2,95	2,27	1,68	1,18		
0,21	33,36	25,89	20,90	17,34	14,67	12,60	10,94	9,58	8,45	7,49	6,67	5,95	5,05	4,02	3,16	2,43	1,81	1,27		
0,22	35,44	27,51	22,22	18,44	15,60	13,40	11,64	10,19	8,99	7,97	7,10	6,35	5,37	4,28	3,37	2,60	1,94	1,37		

Fire dimensional sizing boards Symdeck 100

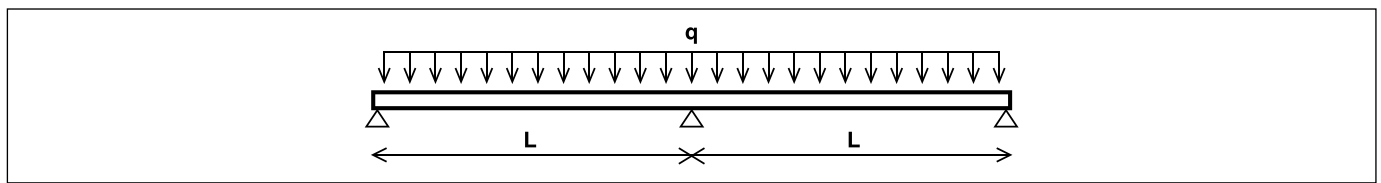

Reinforcement in positions of bending moments								
h (m)	0,15	0,16	0,17	0,18	0,19	0,20	0,21	0,22
Diameter (mm) / Space (mm)	Ø8/125	Ø8/125	Ø10/150	Ø10/150	Ø10/125	Ø10/125	Ø12/150	Ø12/150

Steel sheet thickness: $t=0,75\text{mm}$

Fire resistance: 60 minutes

Plate thickness	Span L (m)																			
h (m)	1,00	1,25	1,50	1,75	2,00	2,25	2,50	2,75	3,00	3,25	3,50	3,75	4,00	4,25	4,50	4,75	5,00	5,25	5,50	
0,15	22,66	17,65	14,31	11,92	9,14	6,74	5,02	3,74	2,77	2,02	1,42	0,93	0,53	0,21						
0,16	24,48	19,06	15,45	12,87	10,01	7,38	5,50	4,10	3,04	2,21	1,55	1,02	0,59	0,23						
0,17	26,33	20,50	16,61	13,83	10,89	8,03	5,98	4,46	3,31	2,41	1,69	1,12	0,64	0,25						
0,18	28,28	22,01	17,83	14,84	11,76	8,67	6,46	4,82	3,57	2,60	1,83	1,21	0,70	0,27						
0,19	30,15	23,46	19,00	15,82	12,64	9,32	6,94	5,18	3,84	2,80	1,97	1,30	0,75	0,30						
0,20	32,15	25,02	20,26	16,86	13,51	9,96	7,42	5,54	4,11	2,99	2,11	1,39	0,81	0,32						
0,21	33,63	26,15	21,17	17,61	14,39	10,61	7,90	5,90	4,38	3,19	2,25	1,48	0,86	0,34						
0,22	35,71	27,78	22,49	18,71	15,26	11,25	8,39	6,26	4,64	3,38	2,38	1,58	0,91	0,36						

Steel sheet thickness: $t=1,00\text{mm}$

Fire resistance: 60 minutes

Plate thickness	Span L (m)																			
h (m)	1,00	1,25	1,50	1,75	2,00	2,25	2,50	2,75	3,00	3,25	3,50	3,75	4,00	4,25	4,50	4,75	5,00	5,25	5,50	
0,15	22,57	17,55	14,21	11,83	10,04	8,65	7,34	5,65	4,36	3,35	2,56	1,91	1,39	0,95	0,58					
0,16	24,39	18,97	15,35	12,77	10,84	9,33	8,05	6,20	4,79	3,69	2,81	2,11	1,53	1,05	0,65					
0,17	26,24	20,40	16,51	13,73	11,65	10,03	8,73	6,75	5,21	4,02	3,07	2,30	1,67	1,15	0,72					
0,18	28,18	21,91	17,73	14,75	12,51	10,77	9,38	7,30	5,64	4,35	3,32	2,50	1,82	1,26	0,78					
0,19	30,06	23,37	18,91	15,72	13,33	11,48	9,99	7,85	6,07	4,68	3,58	2,69	1,96	1,36	0,85					
0,20	32,06	24,92	20,17	16,77	14,22	12,24	10,66	8,40	6,50	5,01	3,84	2,88	2,11	1,46	0,92					
0,21	33,53	26,06	21,08	17,52	14,85	12,77	11,11	8,95	6,92	5,34	4,09	3,08	2,25	1,56	0,99					
0,22	35,62	27,68	22,39	18,61	15,78	13,57	11,81	9,50	7,35	5,68	4,35	3,27	2,39	1,67	1,05					

Steel sheet thickness: $t=1,25\text{mm}$

Fire resistance: 60 minutes

Plate thickness	Span L (m)																			
h (m)	1,00	1,25	1,50	1,75	2,00	2,25	2,50	2,75	3,00	3,25	3,50	3,75	4,00	4,25	4,50	4,75	5,00	5,25	5,50	
0,15	22,47	17,46	14,12	11,73	9,94	8,55	7,44	6,53	5,77	4,69	3,70	2,89	2,24	1,69	1,23	0,85	0,52			
0,16	24,29	18,87	15,26	12,68	10,74	9,24	8,03	7,05	6,23	5,16	4,07	3,19	2,47	1,87	1,37	0,95	0,59			
0,17	26,14	20,31	16,42	13,64	11,56	9,93	8,64	7,58	6,69	5,63	4,44	3,49	2,71	2,06	1,51	1,05	0,66			
0,18	28,09	21,82	17,64	14,65	12,42	10,67	9,28	8,14	7,19	6,10	4,82	3,79	2,94	2,24	1,65	1,15	0,73			
0,19	29,96	23,27	18,81	15,63	13,24	11,38	9,90	8,68	7,67	6,57	5,19	4,08	3,17	2,42	1,79	1,25	0,80			
0,20	31,96	24,83	20,07	16,68	14,13	12,15	10,56	9,26	8,18	7,03	5,56	4,38	3,41	2,60	1,93	1,36	0,87			
0,21	33,44	25,97	20,98	17,42	14,75	12,68	11,02	9,66	8,53	7,50	5,94	4,68	3,64	2,79	2,07	1,46	0,94			
0,22	35,52	27,59	22,30	18,52	15,68	13,48	11,72	10,27	9,07	7,97	6,31	4,97	3,88	2,97	2,21	1,56	1,01			

Steel sheet thickness: $t=1,50\text{mm}$

Fire resistance: 60 minutes

Plate thickness	Span L (m)																			
h (m)	1,00	1,25	1,50	1,75	2,00	2,25	2,50	2,75	3,00	3,25	3,50	3,75	4,00	4,25	4,50	4,75	5,00	5,25	5,50	
0,15	22,39	17,38	14,04	11,65	9,87	8,47	7,36	6,45	5,69	5,05	4,50	3,89	3,10	2,45	1,90	1,44	1,04	0,70		
0,16	24,22	18,80	15,18	12,60	10,66	9,16	7,95	6,97	6,15	5,45	4,86	4,29	3,43	2,71	2,11	1,60	1,17	0,80		
0,17	26,06	20,23	16,34	13,56	11,48	9,86	8,56	7,50	6,61	5,87	5,22	4,67	3,75	2,97	2,32	1,77	1,30	0,89		
0,18	28,01	21,74	17,56	14,58	12,34	10,60	9,20	8,06	7,11	6,31	5,62	5,02	4,08	3,24	2,53	1,94	1,43	0,99		
0,19	29,88	23,19	18,74	15,55	13,16	11,30	9,82	8,60	7,59	6,73	5,99	5,36	4,40	3,50	2,74	2,10	1,55	1,08		
0,20	31,88	24,75	19,99	16,60	14,05	12,07	10,48	9,18	8,10	7,19	6,41	5,73	4,72	3,76	2,95	2,27	1,68	1,18		
0,21	33,36	25,89	20,90	17,34	14,67	12,60	10,94	9,58	8,45	7,49	6,67	5,95	5,05	4,02	3,16	2,43	1,81	1,27		
0,22	35,44	27,51	22,22	18,44	15,60	13,40	11,64	10,19	8,99	7,97	7,10	6,35	5,37	4,28	3,37	2,60	1,94	1,37		

□ Without additional reinforcement. □ 1ø6 □ 1ø8 □ 1ø10 □ 1ø12 □ 1ø14

Fire dimensional sizing boards Symdeck 100

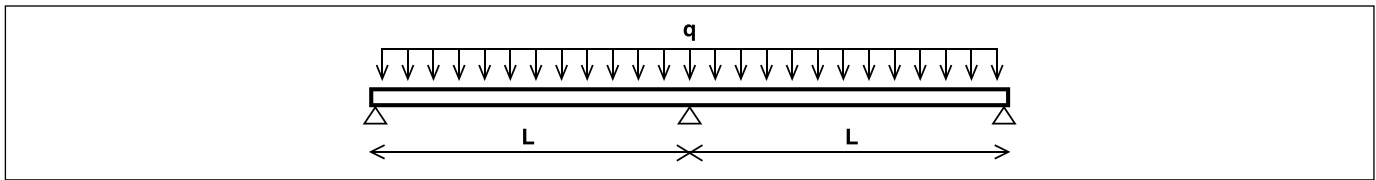

Reinforcement in positions of bending moments								
h (m)	0,15	0,16	0,17	0,18	0,19	0,20	0,21	0,22
Diameter (mm) / Space (mm)	Ø8/125	Ø8/125	Ø10/150	Ø10/150	Ø10/125	Ø10/125	Ø12/150	Ø12/150

Steel sheet thickness: $t=0,75\text{mm}$

Fire resistance: 90 minutes

Plate thickness	Span L (m)																			
h (m)	1,00	1,25	1,50	1,75	2,00	2,25	2,50	2,75	3,00	3,25	3,50	3,75	4,00	4,25	4,50	4,75	5,00	5,25	5,50	
0,15	22,66	17,65	14,31	11,92	9,14	6,74	5,02	3,74	2,77	2,02	1,42	0,93	0,53	0,21						
0,16	24,48	19,06	15,45	12,87	10,01	7,38	5,50	4,10	3,04	2,21	1,55	1,02	0,59	0,23						
0,17	26,33	20,50	16,61	13,83	10,89	8,03	5,98	4,46	3,31	2,41	1,69	1,12	0,64	0,25						
0,18	28,28	22,01	17,83	14,84	11,76	8,67	6,46	4,82	3,57	2,60	1,83	1,21	0,70	0,27						
0,19	30,15	23,46	19,00	15,82	12,64	9,32	6,94	5,18	3,84	2,80	1,97	1,30	0,75	0,30						
0,20	32,15	25,02	20,26	16,86	13,51	9,96	7,42	5,54	4,11	2,99	2,11	1,39	0,81	0,32						
0,21	33,63	26,15	21,17	17,61	14,39	10,61	7,90	5,90	4,38	3,19	2,25	1,48	0,86	0,34						
0,22	35,71	27,78	22,49	18,71	15,26	11,25	8,39	6,26	4,64	3,38	2,38	1,58	0,91	0,36						

Steel sheet thickness: $t=1,00\text{mm}$

Fire resistance: 90 minutes

Plate thickness	Span L (m)																			
h (m)	1,00	1,25	1,50	1,75	2,00	2,25	2,50	2,75	3,00	3,25	3,50	3,75	4,00	4,25	4,50	4,75	5,00	5,25	5,50	
0,15	22,57	17,55	14,21	11,83	10,04	8,65	7,94	6,65	4,96	3,95	2,56	1,91	1,39	0,95	0,58					
0,16	24,39	18,97	15,35	12,77	10,84	9,33	8,05	6,20	4,79	3,69	2,81	2,11	1,53	1,05	0,65					
0,17	26,24	20,40	16,51	13,73	11,65	10,03	8,73	6,75	5,21	4,02	3,07	2,30	1,67	1,15	0,72					
0,18	28,18	21,91	17,73	14,75	12,51	10,77	9,38	7,30	5,64	4,35	3,32	2,50	1,82	1,26	0,78					
0,19	30,06	23,37	18,91	15,72	13,33	11,48	9,99	7,85	6,07	4,68	3,58	2,69	1,96	1,36	0,85					
0,20	32,06	24,92	20,17	16,77	14,22	12,24	10,66	8,40	6,50	5,01	3,84	2,88	2,11	1,46	0,92					
0,21	33,53	26,06	21,08	17,52	14,85	12,77	11,11	8,95	6,92	5,34	4,09	3,08	2,25	1,56	0,99					
0,22	35,62	27,68	22,39	18,61	15,78	13,57	11,81	9,50	7,35	5,68	4,35	3,27	2,39	1,67	1,05					

Steel sheet thickness: $t=1,25\text{mm}$

Fire resistance: 90 minutes

Plate thickness	Span L (m)																			
h (m)	1,00	1,25	1,50	1,75	2,00	2,25	2,50	2,75	3,00	3,25	3,50	3,75	4,00	4,25	4,50	4,75	5,00	5,25	5,50	
0,15	22,47	17,46	14,12	11,73	9,94	8,55	7,44	6,53	5,77	4,69	3,70	2,89	2,24	1,69	1,23	0,85	0,52			
0,16	24,29	18,87	15,26	12,68	10,74	9,24	8,03	7,05	6,23	5,16	4,07	3,19	2,47	1,87	1,37	0,95	0,59			
0,17	26,14	20,31	16,42	13,64	11,56	9,93	8,64	7,58	6,69	5,63	4,44	3,49	2,71	2,06	1,51	1,05	0,66			
0,18	28,09	21,82	17,64	14,65	12,42	10,67	9,28	8,14	7,19	6,10	4,82	3,79	2,94	2,24	1,65	1,15	0,73			
0,19	29,96	23,27	18,81	15,63	13,24	11,38	9,90	8,68	7,67	6,57	5,19	4,08	3,17	2,42	1,79	1,25	0,80			
0,20	31,96	24,83	20,07	16,68	14,13	12,15	10,56	9,26	8,18	7,03	5,56	4,38	3,41	2,60	1,93	1,36	0,87			
0,21	33,44	25,97	20,98	17,42	14,75	12,68	11,02	9,66	8,53	7,50	5,94	4,68	3,64	2,79	2,07	1,46	0,94			
0,22	35,52	27,59	22,30	18,52	15,68	13,48	11,72	10,27	9,07	7,97	6,31	4,97	3,88	2,97	2,21	1,56	1,01			

Steel sheet thickness: $t=1,50\text{mm}$

Fire resistance: 90 minutes

Plate thickness	Span L (m)																			
h (m)	1,00	1,25	1,50	1,75	2,00	2,25	2,50	2,75	3,00	3,25	3,50	3,75	4,00	4,25	4,50	4,75	5,00	5,25	5,50	
0,15	22,39	17,38	14,04	11,65	9,87	8,47	7,36	6,45	5,69	5,05	4,50	3,89	3,10	2,45	1,90	1,44	1,04	0,70		
0,16	24,22	18,80	15,18	12,60	10,66	9,16	7,95	6,97	6,15	5,45	4,86	4,29	3,43	2,71	2,11	1,60	1,17	0,80		
0,17	26,06	20,23	16,34	13,56	11,48	9,86	8,56	7,50	6,61	5,87	5,22	4,67	3,75	2,97	2,32	1,77	1,30	0,89		
0,18	28,01	21,74	17,56	14,58	12,34	10,60	9,20	8,06	7,11	6,31	5,62	5,02	4,08	3,24	2,53	1,94	1,43	0,99		
0,19	29,88	23,19	18,74	15,55	13,16	11,30	9,82	8,60	7,59	6,73	5,99	5,36	4,40	3,50	2,74	2,10	1,55	1,08		
0,20	31,88	24,75	19,99	16,60	14,05	12,07	10,48	9,18	8,10	7,19	6,41	5,73	4,72	3,76	2,95	2,27	1,68	1,18		
0,21	33,36	25,89	20,90	17,34	14,67	12,60	10,94	9,58	8,45	7,49	6,67	5,95	5,05	4,02	3,16	2,43	1,81	1,27		
0,22	35,44	27,51	22,22	18,44	15,60	13,40	11,64	10,19	8,99	7,97	7,10	6,35	5,37	4,28	3,37	2,60	1,94	1,37		

1ø14 1ø12 1ø10 1ø8 1ø6 Without additional reinforcement.

Fire dimensional sizing boards Symdeck 100

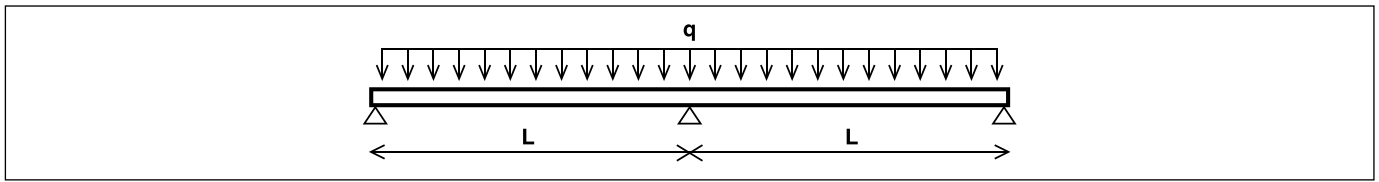

Reinforcement in positions of bending moments								
h (m)	0,15	0,16	0,17	0,18	0,19	0,20	0,21	0,22
Diameter (mm) / Space (mm)	Ø8/125	Ø8/125	Ø10/150	Ø10/150	Ø10/125	Ø10/125	Ø12/150	Ø12/150

Steel sheet thickness: $t=0,75\text{mm}$

Fire resistance: 120 minutes

Plate thickness	Span L (m)																			
h (m)	1	1,25	1,5	1,75	2	2,25	2,5	2,75	3	3,25	3,5	3,75	4	4,25	4,5	4,75	5	5,25	5,5	
0,15	22,66	17,65	14,31	11,92	9,14	6,74	5,02	3,74	2,77	2,02	1,42	0,93	0,53	0,21						
0,16	24,48	19,06	15,45	12,87	10,01	7,38	5,50	4,10	3,04	2,21	1,55	1,02	0,59	0,23						
0,17	26,33	20,50	16,61	13,83	10,89	8,03	5,98	4,46	3,31	2,41	1,69	1,12	0,64	0,25						
0,18	28,28	22,01	17,83	14,84	11,76	8,67	6,46	4,82	3,57	2,60	1,83	1,21	0,70	0,27						
0,19	30,15	23,46	19,00	15,82	12,64	9,32	6,94	5,18	3,84	2,80	1,97	1,30	0,75	0,30						
0,20	32,15	25,02	20,26	16,86	13,51	9,96	7,42	5,54	4,11	2,99	2,11	1,39	0,81	0,32						
0,21	33,63	26,15	21,17	17,61	14,39	10,61	7,90	5,90	4,38	3,19	2,25	1,48	0,86	0,34						
0,22	35,71	27,78	22,49	18,71	15,26	11,25	8,39	6,26	4,64	3,38	2,38	1,58	0,91	0,36						

Steel sheet thickness: $t=1,00\text{mm}$

Fire resistance: 120 minutes

Plate thickness	Span L (m)																			
h (m)	1,00	1,25	1,50	1,75	2,00	2,25	2,50	2,75	3,00	3,25	3,50	3,75	4,00	4,25	4,50	4,75	5,00	5,25	5,50	
0,15	22,57	17,55	14,21	11,83	10,04	8,65	7,94	6,65	4,96	3,95	2,56	1,91	1,39	0,95	0,58					
0,16	24,39	18,97	15,35	12,77	10,84	9,33	8,05	6,20	4,79	3,69	2,81	2,11	1,53	1,05	0,65					
0,17	26,24	20,40	16,51	13,73	11,65	10,03	8,73	6,75	5,21	4,02	3,07	2,30	1,67	1,15	0,72					
0,18	28,18	21,91	17,73	14,75	12,51	10,77	9,38	7,30	5,64	4,35	3,32	2,50	1,82	1,26	0,78					
0,19	30,06	23,37	18,91	15,72	13,33	11,48	9,99	7,85	6,07	4,68	3,58	2,69	1,96	1,36	0,85					
0,20	32,06	24,92	20,17	16,77	14,22	12,24	10,66	8,40	6,50	5,01	3,84	2,88	2,11	1,46	0,92					
0,21	33,53	26,06	21,08	17,52	14,85	12,77	11,11	8,95	6,92	5,34	4,09	3,08	2,25	1,56	0,99					
0,22	35,62	27,68	22,39	18,61	15,78	13,57	11,81	9,50	7,35	5,68	4,35	3,27	2,39	1,67	1,05					

Steel sheet thickness: $t=1,25\text{mm}$

Fire resistance: 120 minutes

Plate thickness	Span L (m)																			
h (m)	1,00	1,25	1,50	1,75	2,00	2,25	2,50	2,75	3,00	3,25	3,50	3,75	4,00	4,25	4,50	4,75	5,00	5,25	5,50	
0,15	22,47	17,46	14,12	11,73	9,94	8,55	7,44	6,53	5,77	4,69	3,70	2,89	2,24	1,69	1,23	0,85	0,52			
0,16	24,29	18,87	15,26	12,68	10,74	9,24	8,03	7,05	6,23	5,16	4,07	3,19	2,47	1,87	1,37	0,95	0,59			
0,17	26,14	20,31	16,42	13,64	11,56	9,93	8,64	7,58	6,69	5,63	4,44	3,49	2,71	2,06	1,51	1,05	0,66			
0,18	28,09	21,82	17,64	14,65	12,42	10,67	9,28	8,14	7,19	6,10	4,82	3,79	2,94	2,24	1,65	1,15	0,73			
0,19	29,96	23,27	18,81	15,63	13,24	11,38	9,90	8,68	7,67	6,57	5,19	4,08	3,17	2,42	1,79	1,25	0,80			
0,20	31,96	24,83	20,07	16,68	14,13	12,15	10,56	9,26	8,18	7,03	5,56	4,38	3,41	2,60	1,93	1,36	0,87			
0,21	33,44	25,97	20,98	17,42	14,75	12,68	11,02	9,66	8,53	7,50	5,94	4,68	3,64	2,79	2,07	1,46	0,94			
0,22	35,52	27,59	22,30	18,52	15,68	13,48	11,72	10,27	9,07	7,97	6,31	4,97	3,88	2,97	2,21	1,56	1,01			

Steel sheet thickness: $t=1,50\text{mm}$

Fire resistance: 120 minutes

Plate thickness	Span L (m)																			
h (m)	1,00	1,25	1,50	1,75	2,00	2,25	2,50	2,75	3,00	3,25	3,50	3,75	4,00	4,25	4,50	4,75	5,00	5,25	5,50	
0,15	22,39	17,38	14,04	11,65	9,87	8,47	7,36	6,45	5,69	5,05	4,50	3,89	3,10	2,45	1,90	1,44	1,04	0,70		
0,16	24,22	18,80	15,18	12,60	10,66	9,16	7,95	6,97	6,15	5,45	4,86	4,29	3,43	2,71	2,11	1,60	1,17	0,80		
0,17	26,06	20,23	16,34	13,56	11,48	9,86	8,56	7,50	6,61	5,87	5,22	4,67	3,75	2,97	2,32	1,77	1,30	0,89		
0,18	28,01	21,74	17,56	14,58	12,34	10,60	9,20	8,06	7,11	6,31	5,62	5,02	4,08	3,24	2,53	1,94	1,43	0,99		
0,19	29,88	23,19	18,74	15,55	13,16	11,30	9,82	8,60	7,59	6,73	5,99	5,36	4,40	3,50	2,74	2,10	1,55	1,08		
0,20	31,88	24,75	19,99	16,60	14,05	12,07	10,48	9,18	8,10	7,19	6,41	5,73	4,72	3,76	2,95	2,27	1,68	1,18		
0,21	33,36	25,89	20,90	17,34	14,67	12,60	10,94	9,58	8,45	7,49	6,67	5,95	5,05	4,02	3,16	2,43	1,81	1,27		
0,22	35,44	27,51	22,22	18,44	15,60	13,40	11,64	10,19	8,99	7,97	7,10	6,35	5,37	4,28	3,37	2,60	1,94	1,37		

□ Without additional reinforcement. □ 1ø6 □ 1ø8 □ 1ø10 □ 1ø12 □ 1ø14

Fire dimensional sizing boards Symdeck 100

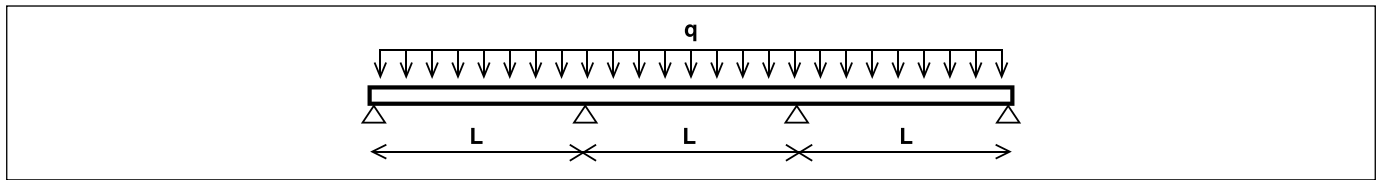

Reinforcement in positions of bending moments								
h (m)	0,15	0,16	0,17	0,18	0,19	0,20	0,21	0,22
Diameter (mm) / Space (mm)	Ø8/125	Ø8/125	Ø10/150	Ø10/150	Ø10/125	Ø10/125	Ø12/150	Ø12/150

Steel sheet thickness: **t=0,75mm**

Fire resistance: **30 minutes**

Plate thickness	Span L (m)																			
h (m)	1,00	1,25	1,50	1,75	2,00	2,25	2,50	2,75	3,00	3,25	3,50	3,75	4,00	4,25	4,50	4,75	5,00	5,25	5,50	
0,15	23,70	18,48	15,00	12,52	9,14	6,74	5,02	3,74	2,77	2,02	1,42	0,93	0,53	0,21						
0,16	25,61	19,97	16,20	13,51	10,01	7,38	5,50	4,10	3,04	2,21	1,55	1,02	0,59	0,23						
0,17	27,55	21,47	17,42	14,52	10,89	8,03	5,98	4,46	3,31	2,41	1,69	1,12	0,64	0,25						
0,18	29,58	23,05	18,70	15,59	11,76	8,67	6,46	4,82	3,57	2,60	1,83	1,21	0,70	0,27						
0,19	31,54	24,58	19,93	16,61	12,64	9,32	6,94	5,18	3,84	2,80	1,97	1,30	0,75	0,30						
0,20	33,64	26,21	21,25	17,71	13,51	9,96	7,42	5,54	4,11	2,99	2,11	1,39	0,81	0,32						
0,21	35,18	27,40	22,21	18,50	14,39	10,61	7,90	5,90	4,38	3,19	2,25	1,48	0,86	0,34						
0,22	37,36	29,10	23,59	19,65	15,26	11,25	8,39	6,26	4,64	3,38	2,38	1,58	0,91	0,36						

Steel sheet thickness: **t=1,00mm**

Fire resistance: **30 minutes**

Plate thickness	Span L (m)																			
h (m)	1,00	1,25	1,50	1,75	2,00	2,25	2,50	2,75	3,00	3,25	3,50	3,75	4,00	4,25	4,50	4,75	5,00	5,25	5,50	
0,15	23,61	18,39	14,91	12,42	10,56	9,11	7,95	6,55	5,12	4,00	3,12	2,40	1,82	1,33	0,92	0,58				
0,16	25,52	19,87	16,11	13,42	11,40	9,83	8,58	7,19	5,62	4,40	3,43	2,64	2,00	1,47	1,02	0,64				
0,17	27,45	21,37	17,32	14,43	12,26	10,57	9,22	7,83	6,12	4,79	3,74	2,88	2,19	1,61	1,12	0,71				
0,18	29,49	22,96	18,60	15,49	13,16	11,35	9,90	8,46	6,62	5,18	4,04	3,12	2,37	1,75	1,22	0,78				
0,19	31,45	24,48	19,84	16,52	14,03	12,10	10,55	9,10	7,12	5,58	4,35	3,37	2,56	1,89	1,32	0,85				
0,20	33,54	26,11	21,16	17,62	14,96	12,90	11,25	9,73	7,62	5,97	4,66	3,61	2,74	2,02	1,42	0,91				
0,21	35,09	27,30	22,11	18,41	15,63	13,46	11,73	10,32	8,12	6,37	4,97	3,85	2,93	2,16	1,52	0,98				
0,22	37,27	29,00	23,49	19,56	16,60	14,31	12,47	10,97	8,62	6,76	5,28	4,09	3,11	2,30	1,62	1,05				

Steel sheet thickness: **t=1,25mm**

Fire resistance: **30 minutes**

Plate thickness	Span L (m)																			
h (m)	1,00	1,25	1,50	1,75	2,00	2,25	2,50	2,75	3,00	3,25	3,50	3,75	4,00	4,25	4,50	4,75	5,00	5,25	5,50	
0,15	23,51	18,29	14,82	12,33	10,47	9,02	7,86	6,91	5,95	4,69	3,70	2,89	2,24	1,69	1,23	0,85	0,52			
0,16	25,42	19,78	16,01	13,32	11,31	9,74	8,49	7,46	6,53	5,16	4,07	3,19	2,47	1,87	1,37	0,95	0,59			
0,17	27,36	21,28	17,23	14,33	12,16	10,47	9,12	8,02	7,10	5,63	4,44	3,49	2,71	2,06	1,51	1,05	0,66			
0,18	29,39	22,86	18,51	15,40	13,07	11,25	9,80	8,62	7,63	6,10	4,82	3,79	2,94	2,24	1,65	1,15	0,73			
0,19	31,36	24,39	19,74	16,43	13,94	12,00	10,45	9,19	8,13	6,57	5,19	4,08	3,17	2,42	1,79	1,25	0,80			
0,20	33,45	26,02	21,06	17,52	14,87	12,81	11,16	9,80	8,68	7,03	5,56	4,38	3,41	2,60	1,93	1,36	0,87			
0,21	35,00	27,21	22,02	18,31	15,53	13,37	11,64	10,22	9,04	7,50	5,94	4,68	3,64	2,79	2,07	1,46	0,94			
0,22	37,18	28,91	23,40	19,46	16,51	14,21	12,38	10,87	9,62	7,97	6,31	4,97	3,88	2,97	2,21	1,56	1,01			

Steel sheet thickness: **t=1,50mm**

Fire resistance: **30 minutes**

Plate thickness	Span L (m)																			
h (m)	1,00	1,25	1,50	1,75	2,00	2,25	2,50	2,75	3,00	3,25	3,50	3,75	4,00	4,25	4,50	4,75	5,00	5,25	5,50	
0,15	23,43	18,22	14,74	12,25	10,39	8,94	7,78	6,83	6,04	5,37	4,79	3,89	3,10	2,45	1,90	1,44	1,04	0,70		
0,16	25,34	19,70	15,93	13,24	11,23	9,66	8,41	7,38	6,52	5,80	5,18	4,29	3,43	2,71	2,11	1,60	1,17	0,80		
0,17	27,28	21,20	17,15	14,25	12,08	10,39	9,04	7,94	7,02	6,24	5,57	4,69	3,75	2,97	2,32	1,77	1,30	0,89		
0,18	29,31	22,78	18,43	15,32	12,99	11,17	9,72	8,54	7,55	6,71	5,99	5,09	4,08	3,24	2,53	1,94	1,43	0,99		
0,19	31,28	24,31	19,66	16,35	13,86	11,92	10,37	9,11	8,05	7,16	6,39	5,49	4,40	3,50	2,74	2,10	1,55	1,08		
0,20	33,37	25,94	20,98	17,44	14,79	12,73	11,08	9,72	8,60	7,65	6,83	5,89	4,72	3,76	2,95	2,27	1,68	1,18		
0,21	34,92	27,13	21,94	18,23	15,45	13,29	11,56	10,14	8,96	7,97	7,11	6,29	5,05	4,02	3,16	2,43	1,81	1,27		
0,22	37,10	28,83	23,32	19,38	16,43	14,13	12,30	10,79	9,54	8,48	7,57	6,69	5,37	4,28	3,37	2,60	1,94	1,37		

Fire dimensional sizing boards Symdeck 100

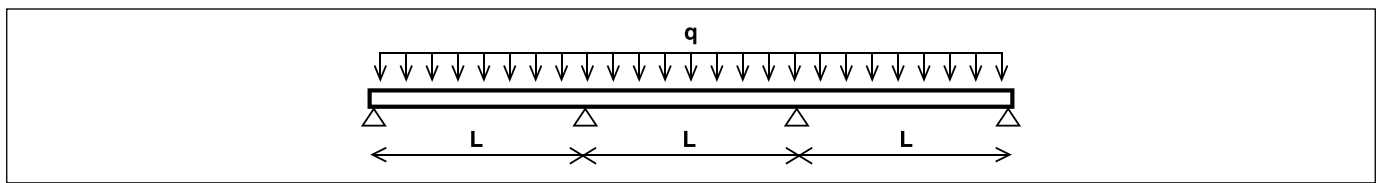

Reinforcement in positions of bending moments								
h (m)	0,15	0,16	0,17	0,18	0,19	0,20	0,21	0,22
Diameter (mm) / Space (mm)	Ø8/125	Ø8/125	Ø10/150	Ø10/150	Ø10/125	Ø10/125	Ø12/150	Ø12/150

Steel sheet thickness: t=0,75mm

Fire resistance: 60 minutes

Plate thickness	Span L (m)																			
h (m)	1,00	1,25	1,50	1,75	2,00	2,25	2,50	2,75	3,00	3,25	3,50	3,75	4,00	4,25	4,50	4,75	5,00	5,25	5,50	
0,15	23,70	18,48	15,00	12,52	9,14	6,74	5,02	3,74	2,77	2,02	1,42	0,93	0,53	0,21						
0,16	25,61	19,97	16,20	13,51	10,01	7,38	5,50	4,10	3,04	2,21	1,55	1,02	0,59	0,23						
0,17	27,55	21,47	17,42	14,52	10,89	8,03	5,98	4,46	3,31	2,41	1,69	1,12	0,64	0,25						
0,18	29,58	23,05	18,70	15,59	11,76	8,67	6,46	4,82	3,57	2,60	1,83	1,21	0,70	0,27						
0,19	31,54	24,58	19,93	16,61	12,64	9,32	6,94	5,18	3,84	2,80	1,97	1,30	0,75	0,30						
0,20	33,64	26,21	21,25	17,71	13,51	9,96	7,42	5,54	4,11	2,99	2,11	1,39	0,81	0,32						
0,21	35,18	27,40	22,21	18,50	14,39	10,61	7,90	5,90	4,38	3,19	2,25	1,48	0,86	0,34						
0,22	37,36	29,10	23,59	19,65	15,26	11,25	8,39	6,26	4,64	3,38	2,38	1,58	0,91	0,36						

Steel sheet thickness: t=1,00mm

Fire resistance: 60 minutes

Plate thickness	Span L (m)																			
h (m)	1,00	1,25	1,50	1,75	2,00	2,25	2,50	2,75	3,00	3,25	3,50	3,75	4,00	4,25	4,50	4,75	5,00	5,25	5,50	
0,15	23,61	18,39	14,91	12,42	10,56	9,11	7,95	6,55	5,12	4,00	3,12	2,40	1,82	1,33	0,92	0,58				
0,16	25,52	19,87	16,11	13,42	11,40	9,83	8,58	7,19	5,62	4,40	3,43	2,64	2,00	1,47	1,02	0,64				
0,17	27,45	21,37	17,32	14,43	12,26	10,57	9,22	7,83	6,12	4,79	3,74	2,88	2,19	1,61	1,12	0,71				
0,18	29,49	22,96	18,60	15,49	13,16	11,35	9,90	8,46	6,62	5,18	4,04	3,12	2,37	1,75	1,22	0,78				
0,19	31,45	24,48	19,84	16,52	14,03	12,10	10,55	9,10	7,12	5,58	4,35	3,37	2,56	1,89	1,32	0,85				
0,20	33,54	26,11	21,16	17,62	14,96	12,90	11,25	9,73	7,62	5,97	4,66	3,61	2,74	2,02	1,42	0,91				
0,21	35,09	27,30	22,11	18,41	15,63	13,46	11,73	10,32	8,12	6,37	4,97	3,85	2,93	2,16	1,52	0,98				
0,22	37,27	29,00	23,49	19,56	16,60	14,31	12,47	10,97	8,62	6,76	5,28	4,09	3,11	2,30	1,62	1,05				

Steel sheet thickness: t=1,25mm

Fire resistance: 60 minutes

Plate thickness	Span L (m)																			
h (m)	1,00	1,25	1,50	1,75	2,00	2,25	2,50	2,75	3,00	3,25	3,50	3,75	4,00	4,25	4,50	4,75	5,00	5,25	5,50	
0,15	23,51	18,29	14,82	12,33	10,47	9,02	7,86	6,91	5,95	4,69	3,70	2,89	2,24	1,69	1,23	0,85	0,52			
0,16	25,42	19,78	16,01	13,32	11,31	9,74	8,49	7,46	6,53	5,16	4,07	3,19	2,47	1,87	1,37	0,95	0,59			
0,17	27,36	21,28	17,23	14,33	12,16	10,47	9,12	8,02	7,10	5,63	4,44	3,49	2,71	2,06	1,51	1,05	0,66			
0,18	29,39	22,86	18,51	15,40	13,07	11,25	9,80	8,62	7,63	6,10	4,82	3,79	2,94	2,24	1,65	1,15	0,73			
0,19	31,36	24,39	19,74	16,43	13,94	12,00	10,45	9,19	8,13	6,57	5,19	4,08	3,17	2,42	1,79	1,25	0,80			
0,20	33,45	26,02	21,06	17,52	14,87	12,81	11,16	9,80	8,68	7,03	5,56	4,38	3,41	2,60	1,93	1,36	0,87			
0,21	35,00	27,21	22,02	18,31	15,53	13,37	11,64	10,22	9,04	7,50	5,94	4,68	3,64	2,79	2,07	1,46	0,94			
0,22	37,18	28,91	23,40	19,46	16,51	14,21	12,38	10,87	9,62	7,97	6,31	4,97	3,88	2,97	2,21	1,56	1,01			

Steel sheet thickness: t=1,50mm

Fire resistance: 60 minutes

Plate thickness	Span L (m)																			
h (m)	1,00	1,25	1,50	1,75	2,00	2,25	2,50	2,75	3,00	3,25	3,50	3,75	4,00	4,25	4,50	4,75	5,00	5,25	5,50	
0,15	23,43	18,22	14,74	12,25	10,39	8,94	7,78	6,83	6,04	5,37	4,79	3,89	3,10	2,45	1,90	1,44	1,04	0,70		
0,16	25,34	19,70	15,93	13,24	11,23	9,66	8,41	7,38	6,52	5,80	5,18	4,29	3,43	2,71	2,11	1,60	1,17	0,80		
0,17	27,28	21,20	17,15	14,25	12,08	10,39	9,04	7,94	7,02	6,24	5,57	4,69	3,75	2,97	2,32	1,77	1,30	0,89		
0,18	29,31	22,78	18,43	15,32	12,99	11,17	9,72	8,54	7,55	6,71	5,99	5,09	4,08	3,24	2,53	1,94	1,43	0,99		
0,19	31,28	24,31	19,66	16,35	13,86	11,92	10,37	9,11	8,05	7,16	6,39	5,49	4,40	3,50	2,74	2,10	1,55	1,08		
0,20	33,37	25,94	20,98	17,44	14,79	12,73	11,08	9,72	8,60	7,65	6,83	5,89	4,72	3,76	2,95	2,27	1,68	1,18		
0,21	34,92	27,13	21,94	18,23	15,45	13,29	11,56	10,14	8,96	7,97	7,11	6,29	5,05	4,02	3,16	2,43	1,81	1,27		
0,22	37,10	28,83	23,32	19,38	16,43	14,13	12,30	10,79	9,54	8,48	7,57	6,69	5,37	4,28	3,37	2,60	1,94	1,37		

□ Without additional reinforcement. □ 1ø6 □ 1ø8 □ 1ø10 □ 1ø12 □ 1ø14

Fire dimensional sizing boards Symdeck 100

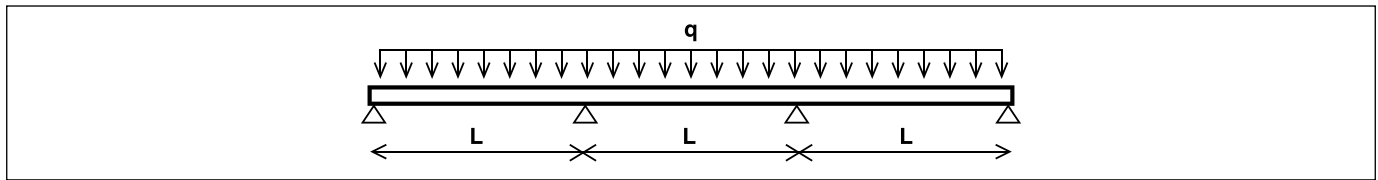

Reinforcement in positions of bending moments								
h (m)	0,15	0,16	0,17	0,18	0,19	0,20	0,21	0,22
Diameter (mm) / Space (mm)	Ø8/125	Ø8/125	Ø10/150	Ø10/150	Ø10/125	Ø10/125	Ø12/150	Ø12/150

Steel sheet thickness: t=0,75mm

Fire resistance: 90 minutes

Plate thickness	Span L (m)																			
h (m)	1,00	1,25	1,50	1,75	2,00	2,25	2,50	2,75	3,00	3,25	3,50	3,75	4,00	4,25	4,50	4,75	5,00	5,25	5,50	
0,15	23,70	18,48	15,00	12,52	9,14	6,74	5,02	3,74	2,77	2,02	1,42	0,93	0,53	0,21						
0,16	25,61	19,97	16,20	13,51	10,01	7,38	5,50	4,10	3,04	2,21	1,55	1,02	0,59	0,23						
0,17	27,55	21,47	17,42	14,52	10,89	8,03	5,98	4,46	3,31	2,41	1,69	1,12	0,64	0,25						
0,18	29,58	23,05	18,70	15,59	11,76	8,67	6,46	4,82	3,57	2,60	1,83	1,21	0,70	0,27						
0,19	31,54	24,58	19,93	16,61	12,64	9,32	6,94	5,18	3,84	2,80	1,97	1,30	0,75	0,30						
0,20	33,64	26,21	21,25	17,71	13,51	9,96	7,42	5,54	4,11	2,99	2,11	1,39	0,81	0,32						
0,21	35,18	27,40	22,21	18,50	14,39	10,61	7,90	5,90	4,38	3,19	2,25	1,48	0,86	0,34						
0,22	37,36	29,10	23,59	19,65	15,26	11,25	8,39	6,26	4,64	3,38	2,38	1,58	0,91	0,36						

Steel sheet thickness: t=1,00mm

Fire resistance: 90 minutes

Plate thickness	Span L (m)																			
h (m)	1,00	1,25	1,50	1,75	2,00	2,25	2,50	2,75	3,00	3,25	3,50	3,75	4,00	4,25	4,50	4,75	5,00	5,25	5,50	
0,15	23,61	18,39	14,91	12,42	10,56	9,11	7,95	6,55	5,12	4,90	3,12	2,40	1,82	1,33	0,92	0,58				
0,16	25,52	19,87	16,11	13,42	11,40	9,83	8,58	7,19	5,62	4,40	3,43	2,64	2,00	1,47	1,02	0,64				
0,17	27,45	21,37	17,32	14,43	12,26	10,57	9,22	7,83	6,12	4,79	3,74	2,88	2,19	1,61	1,12	0,71				
0,18	29,49	22,96	18,60	15,49	13,16	11,35	9,90	8,46	6,62	5,18	4,04	3,12	2,37	1,75	1,22	0,78				
0,19	31,45	24,48	19,84	16,52	14,03	12,10	10,55	9,10	7,12	5,58	4,35	3,37	2,56	1,89	1,32	0,85				
0,20	33,54	26,11	21,16	17,62	14,96	12,90	11,25	9,73	7,62	5,97	4,66	3,61	2,74	2,02	1,42	0,91				
0,21	35,09	27,30	22,11	18,41	15,63	13,46	11,73	10,32	8,12	6,37	4,97	3,85	2,93	2,16	1,52	0,98				
0,22	37,27	29,00	23,49	19,56	16,60	14,31	12,47	10,97	8,62	6,76	5,28	4,09	3,11	2,30	1,62	1,05				

Steel sheet thickness: t=1,25mm

Fire resistance: 90 minutes

Plate thickness	Span L (m)																			
h (m)	1,00	1,25	1,50	1,75	2,00	2,25	2,50	2,75	3,00	3,25	3,50	3,75	4,00	4,25	4,50	4,75	5,00	5,25	5,50	
0,15	23,51	18,29	14,82	12,33	10,47	9,02	7,86	6,91	5,95	4,69	3,70	2,89	2,24	1,69	1,23	0,85	0,52			
0,16	25,42	19,78	16,01	13,32	11,31	9,74	8,49	7,46	6,53	5,16	4,07	3,19	2,47	1,87	1,37	0,95	0,59			
0,17	27,36	21,28	17,23	14,33	12,16	10,47	9,12	8,02	7,10	5,63	4,44	3,49	2,71	2,06	1,51	1,05	0,66			
0,18	29,39	22,86	18,51	15,40	13,07	11,25	9,80	8,62	7,63	6,10	4,82	3,79	2,94	2,24	1,65	1,15	0,73			
0,19	31,36	24,39	19,74	16,43	13,94	12,00	10,45	9,19	8,13	6,57	5,19	4,08	3,17	2,42	1,79	1,25	0,80			
0,20	33,45	26,02	21,06	17,52	14,87	12,81	11,16	9,80	8,68	7,03	5,56	4,38	3,41	2,60	1,93	1,36	0,87			
0,21	35,00	27,21	22,02	18,31	15,53	13,37	11,64	10,22	9,04	7,50	5,94	4,68	3,64	2,79	2,07	1,46	0,94			
0,22	37,18	28,91	23,40	19,46	16,51	14,21	12,38	10,87	9,62	7,97	6,31	4,97	3,88	2,97	2,21	1,56	1,01			

Steel sheet thickness: t=1,50mm

Fire resistance: 90 minutes

Plate thickness	Span L (m)																			
h (m)	1,00	1,25	1,50	1,75	2,00	2,25	2,50	2,75	3,00	3,25	3,50	3,75	4,00	4,25	4,50	4,75	5,00	5,25	5,50	
0,15	23,43	18,22	14,74	12,25	10,39	8,94	7,78	6,83	6,04	5,37	4,79	3,89	3,10	2,45	1,90	1,44	1,04	0,70		
0,16	25,34	19,70	15,93	13,24	11,23	9,66	8,41	7,38	6,52	5,80	5,18	4,29	3,43	2,71	2,11	1,60	1,17	0,80		
0,17	27,28	21,20	17,15	14,25	12,08	10,39	9,04	7,94	7,02	6,24	5,57	4,69	3,75	2,97	2,32	1,77	1,30	0,89		
0,18	29,31	22,78	18,43	15,32	12,99	11,17	9,72	8,54	7,55	6,71	5,99	5,09	4,08	3,24	2,53	1,94	1,43	0,99		
0,19	31,28	24,31	19,66	16,35	13,86	11,92	10,37	9,11	8,05	7,16	6,39	5,49	4,40	3,50	2,74	2,10	1,55	1,08		
0,20	33,37	25,94	20,98	17,44	14,79	12,73	11,08	9,72	8,60	7,65	6,83	5,89	4,72	3,76	2,95	2,27	1,68	1,18		
0,21	34,92	27,13	21,94	18,23	15,45	13,29	11,56	10,14	8,96	7,97	7,11	6,29	5,05	4,02	3,16	2,43	1,81	1,27		
0,22	37,10	28,83	23,32	19,38	16,43	14,13	12,30	10,79	9,54	8,48	7,57	6,69	5,37	4,28	3,37	2,60	1,94	1,37		

Fire dimensional sizing boards Symdeck 100

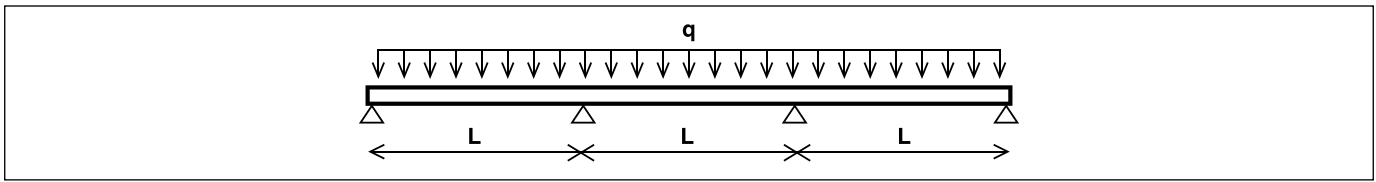

Reinforcement in positions of bending moments

h (m)	0,15	0,16	0,17	0,18	0,19	0,20	0,21	0,22
Diameter (mm) / Space (mm)	Ø8/125	Ø8/125	Ø10/150	Ø10/150	Ø10/125	Ø10/125	Ø12/150	Ø12/150

Steel sheet thickness: t=0,75mm

Fire resistance: 120 minutes

Plate thickness	Span L (m)																			
h (m)	1,00	1,25	1,50	1,75	2,00	2,25	2,50	2,75	3,00	3,25	3,50	3,75	4,00	4,25	4,50	4,75	5,00	5,25	5,50	
0,15	23,70	18,48	15,00	12,52	9,14	6,74	5,02	3,74	2,77	2,02	1,42	0,93	0,53	0,21						
0,16	25,61	19,97	16,20	13,51	10,01	7,38	5,50	4,10	3,04	2,21	1,55	1,02	0,59	0,23						
0,17	27,55	21,47	17,42	14,52	10,89	8,03	5,98	4,46	3,31	2,41	1,69	1,12	0,64	0,25						
0,18	29,58	23,05	18,70	15,59	11,76	8,67	6,46	4,82	3,57	2,60	1,83	1,21	0,70	0,27						
0,19	31,54	24,58	19,93	16,61	12,64	9,32	6,94	5,18	3,84	2,80	1,97	1,30	0,75	0,30						
0,20	33,64	26,21	21,25	17,71	13,51	9,96	7,42	5,54	4,11	2,99	2,11	1,39	0,81	0,32						
0,21	35,18	27,40	22,21	18,50	14,39	10,61	7,90	5,90	4,38	3,19	2,25	1,48	0,86	0,34						
0,22	37,36	29,10	23,59	19,65	15,26	11,25	8,39	6,26	4,64	3,38	2,38	1,58	0,91	0,36						

Steel sheet thickness: t=1,00mm

Fire resistance: 120 minutes

Plate thickness	Span L (m)																			
h (m)	1,00	1,25	1,50	1,75	2,00	2,25	2,50	2,75	3,00	3,25	3,50	3,75	4,00	4,25	4,50	4,75	5,00	5,25	5,50	
0,15	23,61	18,39	14,91	12,42	10,56	9,11	7,94	5,65	4,36	3,35	2,56	1,91	1,39	0,95	0,58					
0,16	25,52	19,87	16,11	13,42	11,40	9,83	8,05	6,20	4,79	3,69	2,81	2,11	1,53	1,05	0,65					
0,17	27,45	21,37	17,32	14,43	12,26	10,57	8,77	6,75	5,21	4,02	3,07	2,30	1,67	1,15	0,72					
0,18	29,49	22,96	18,60	15,49	13,16	11,35	9,48	7,30	5,64	4,35	3,32	2,50	1,82	1,26	0,78					
0,19	31,45	24,48	19,84	16,52	14,03	12,10	10,19	7,85	6,07	4,68	3,58	2,69	1,96	1,36	0,85					
0,20	33,54	26,11	21,16	17,62	14,96	12,90	10,90	8,40	6,50	5,01	3,84	2,88	2,11	1,46	0,92					
0,21	35,09	27,30	22,11	18,41	15,63	13,46	11,61	8,95	6,92	5,34	4,09	3,08	2,25	1,56	0,99					
0,22	37,27	29,00	23,49	19,56	16,60	14,31	12,33	9,50	7,35	5,68	4,35	3,27	2,39	1,67	1,05					

Steel sheet thickness: t=1,25mm

Fire resistance: 120 minutes

Plate thickness	Span L (m)																			
h (m)	1,00	1,25	1,50	1,75	2,00	2,25	2,50	2,75	3,00	3,25	3,50	3,75	4,00	4,25	4,50	4,75	5,00	5,25	5,50	
0,15	23,51	18,29	14,82	12,33	10,47	9,02	7,86	6,91	5,95	4,69	3,70	2,89	2,24	1,69	1,23	0,85	0,52			
0,16	25,42	19,78	16,01	13,32	11,31	9,74	8,49	7,46	6,53	5,16	4,07	3,19	2,47	1,87	1,37	0,95	0,59			
0,17	27,36	21,28	17,23	14,33	12,16	10,47	9,12	8,02	7,10	5,63	4,44	3,49	2,71	2,06	1,51	1,05	0,66			
0,18	29,39	22,86	18,51	15,40	13,07	11,25	9,80	8,62	7,63	6,10	4,82	3,79	2,94	2,24	1,65	1,15	0,73			
0,19	31,36	24,39	19,74	16,43	13,94	12,00	10,45	9,19	8,13	6,57	5,19	4,08	3,17	2,42	1,79	1,25	0,80			
0,20	33,45	26,02	21,06	17,52	14,87	12,81	11,16	9,80	8,68	7,03	5,56	4,38	3,41	2,60	1,93	1,36	0,87			
0,21	35,00	27,21	22,02	18,31	15,53	13,37	11,64	10,22	9,04	7,50	5,94	4,68	3,64	2,79	2,07	1,46	0,94			
0,22	37,18	28,91	23,40	19,46	16,51	14,21	12,38	10,87	9,62	7,97	6,31	4,97	3,88	2,97	2,21	1,56	1,01			

Steel sheet thickness: t=1,50mm

Fire resistance: 120 minutes

Plate thickness	Span L (m)																			
h (m)	1,00	1,25	1,50	1,75	2,00	2,25	2,50	2,75	3,00	3,25	3,50	3,75	4,00	4,25	4,50	4,75	5,00	5,25	5,50	
0,15	23,43	18,22	14,74	12,25	10,39	8,94	7,78	6,83	6,04	5,37	4,79	3,89	3,10	2,45	1,90	1,44	1,04	0,70		
0,16	25,34	19,70	15,93	13,24	11,23	9,66	8,41	7,38	6,52	5,80	5,18	4,29	3,43	2,71	2,11	1,60	1,17	0,80		
0,17	27,28	21,20	17,15	14,25	12,08	10,39	9,04	7,94	7,02	6,24	5,57	4,69	3,75	2,97	2,32	1,77	1,30	0,89		
0,18	29,31	22,78	18,43	15,32	12,99	11,17	9,72	8,54	7,55	6,71	5,99	5,09	4,08	3,24	2,53	1,94	1,43	0,99		
0,19	31,28	24,31	19,66	16,35	13,86	11,92	10,37	9,11	8,05	7,16	6,39	5,49	4,40	3,50	2,74	2,10	1,55	1,08		
0,20	33,37	25,94	20,98	17,44	14,79	12,73	11,08	9,72	8,60	7,65	6,83	5,89	4,72	3,76	2,95	2,27	1,68	1,18		
0,21	34,92	27,13	21,94	18,23	15,45	13,29	11,56	10,14	8,96	7,97	7,11	6,29	5,05	4,02	3,16	2,43	1,81	1,27		
0,22	37,10	28,83	23,32	19,38	16,43	14,13	12,30	10,79	9,54	8,48	7,57	6,69	5,37	4,28	3,37	2,60	1,94	1,37		

□ Without additional reinforcement. □ 1ø6 □ 1ø8 □ 1ø10 □ 1ø12 □ 1ø14

Lightweight steel panel design panels Symdeck 73 (thin-walled section operation consideration)

The marginal loads of steel sheet floors SYMDECK 73 without a composite appearance are given below. These tables can be used for the calculation of light floors (e.g., steel sheet + marine plywood + coating) or for any disposal of steel sheet with light mortars (perlite, tin, etc.), where no mixed operation occurs.

The floor loads are divided into two categories: permanent G and variables Q. The design of those two states:

The operating time functionality (Serviceability limit state – SLS)

For the marginal function, set a load for the colors of the respective beams for two different permissible limits of submersible $L/200$ and $L/300$, where L the length of the product. This load corresponds to the load $G+Q$ according to the load regulation (load safety factors equal to the unit). These loads are symbolized in the tables as $q_{RD-SLS-L/200}$ and $q_{RD-SLS-L/300}$ respectively.

Ultimate limit state – ULS

In the ultimate limit state the maximum load that can be carried by the respective beam based on the drop in bending of the most critical cross section is given. Obviously, the criterion of failure is the excess of the strength of the most critical cross-section and not the creation of a mechanism of plastic joints, since the cross-section of the steel sheet belongs to category 4 of steel cross-sections in accordance with the EC-3, so it has no plastic strength. The calculated load corresponds to the adverse failure load $1.35G+1.5Q$ according to the loading regulation. These loads are symbolized in the tables as q_{RD-ULS} .

Depending on the ratio of permanent and variable loads, the critical inspection may differ.

Example

Even a floor with a permanent load $G=1.0 \text{ kN/m}^2$ and a variable load $Q=5.0 \text{ kN/m}^2$. The sizing of the floor is requested (thickness of steel sheet, distances of supports for static system, beam of three equal openings). The control of ultimate limit state of operation to be done with the maximum acceptable movement $L/300$.

1. Calculation of the design load for the marginal state of functionality:

$$q_{Sd-SLS}=G+Q=1.0+5.0=6.0\text{kN/m}^2$$

2. Calculation of the design load for the failure limit state:

$$q_{Sd-ULS}=1.35G+1.5Q=1.35+1.0+1.5\times 5.0=8.85\text{kN/m}^2$$

3. From the design tables of the beams of three equal openings, the following combinations emerge that satisfy both the criterion of the marginal state of functionality ($q_{Sd-SLS} < q_{Sd-ULS-L/300}$) and the criterion of the marginal state of failure ($q_{Sd-ULS} < q_{Rd-ULS}$).

$$t=0.75\text{mm}, L=2.25\text{m}$$

$$t=1.00\text{mm}, L=2.75\text{m}$$

$$t=1.25\text{mm}, L=3.00\text{m}$$

Lightweight steel panel design panels Symdeck 73

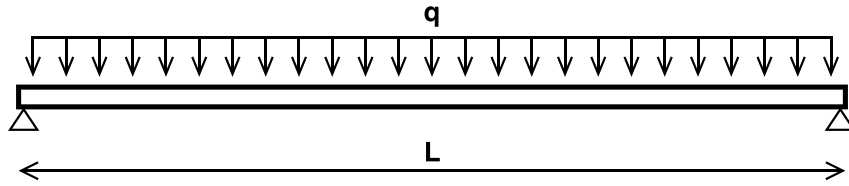

t = 0,75 mm

L (m)	1,50	1,75	2,00	2,25	2,50	2,75	3,00	3,25	3,50	3,75	4,00	4,25	4,50	4,75	5,00	5,25	5,50	5,75	6,00
$q_{Rd-SLS-L/200}$	26,28	16,55	11,09	7,79	5,68	4,27	3,29	2,58	2,07	1,68	1,39	1,16	0,97	0,83	0,71	0,61	0,53	0,47	0,41
$q_{Rd-SLS-L/300}$	17,52	11,03	7,39	5,19	3,78	2,84	2,19	1,72	1,38	1,12	0,92	0,77	0,65	0,55	0,47	0,41	0,36	0,31	0,27
q_{Rd-ULS}	24,39	17,92	13,72	10,84	8,78	7,26	6,10	5,19	4,48	3,90	3,43	3,04	2,71	2,43	2,19	1,99	1,81	1,66	1,52

Ultimate loads in kN/m² for the operation and the ultimate limit states.

t = 1,00 mm

L (m)	1,50	1,75	2,00	2,25	2,50	2,75	3,00	3,25	3,50	3,75	4,00	4,25	4,50	4,75	5,00	5,25	5,50	5,75	6,00
$q_{Rd-SLS-L/200}$	35,17	22,15	14,84	10,42	7,60	5,71	4,40	3,46	2,77	2,25	1,86	1,55	1,30	1,11	0,95	0,82	0,71	0,62	0,55
$q_{Rd-SLS-L/300}$	23,45	14,77	9,89	6,95	5,07	3,81	2,93	2,31	1,85	1,50	1,24	1,03	0,87	0,74	0,63	0,55	0,48	0,42	0,37
q_{Rd-ULS}	32,53	23,9	18,3	14,46	11,71	9,68	8,13	6,93	5,98	5,21	4,58	4,05	3,61	3,24	2,93	2,66	2,42	2,21	2,03

Ultimate loads in kN/m² for the operation and the ultimate limit states.

t = 1,25 mm

L (m)	1,50	1,75	2,00	2,25	2,50	2,75	3,00	3,25	3,50	3,75	4,00	4,25	4,50	4,75	5,00	5,25	5,50	5,75	6,00
$q_{Rd-SLS-L/200}$	44,06	27,75	18,59	13,05	9,52	7,15	5,51	4,33	3,47	2,82	2,32	1,94	1,63	1,39	1,19	1,03	0,89	0,78	0,69
$q_{Rd-SLS-L/300}$	29,37	18,50	12,39	8,70	6,34	4,77	3,67	2,89	2,31	1,88	1,55	1,29	1,09	0,93	0,79	0,69	0,60	0,52	0,46
q_{Rd-ULS}	41,07	30,18	23,1	18,26	14,79	12,22	10,27	8,75	7,54	6,57	5,78	5,12	4,56	4,10	3,70	3,35	3,06	2,80	2,57

Ultimate loads in kN/m² for the operation and the ultimate limit states.

Lightweight steel panel design panels Symdeck 73

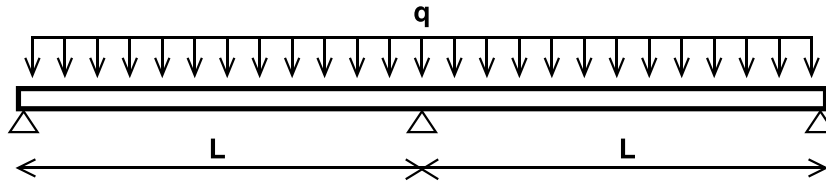

t = 0,75 mm

L (m)	1,50	1,75	2,00	2,25	2,50	2,75	3,00	3,25	3,50	3,75	4,00	4,25	4,50	4,75	5,00	5,25	5,50	5,75	6,00
$q_{Rd-SLS-L/200}$	63,31	39,87	26,71	18,76	13,68	10,27	7,91	6,22	4,98	4,05	3,34	2,78	2,34	1,99	1,71	1,48	1,28	1,12	0,99
$q_{Rd-SLS-L/300}$	42,21	26,58	17,81	12,51	9,12	6,85	5,28	4,15	3,32	2,70	2,23	1,86	1,56	1,33	1,14	0,98	0,86	0,75	0,66
q_{Rd-ULS}	19,10	14,03	10,74	8,49	6,87	5,68	4,77	4,07	3,51	3,06	2,69	2,38	2,12	1,90	1,72	1,56	1,42	1,30	1,19

Ultimate loads in kN/m² for the operation and the ultimate limit states.

t = 1,00 mm

L (m)	1,50	1,75	2,00	2,25	2,50	2,75	3,00	3,25	3,50	3,75	4,00	4,25	4,50	4,75	5,00	5,25	5,50	5,75	6,00
$q_{Rd-SLS-L/200}$	84,72	53,35	35,74	25,1	18,3	13,75	10,59	8,33	6,67	5,42	4,47	3,72	3,14	2,67	2,29	1,98	1,72	1,50	1,32
$q_{Rd-SLS-L/300}$	56,48	35,57	23,83	16,74	12,2	9,17	7,06	5,55	4,45	3,61	2,98	2,48	2,09	1,78	1,52	1,32	1,15	1,00	0,88
q_{Rd-ULS}	28,37	20,84	15,96	12,61	10,21	8,44	7,09	6,04	5,21	4,54	3,99	3,53	3,15	2,83	2,55	2,32	2,11	1,93	1,77

Ultimate loads in kN/m² for the operation and the ultimate limit states.

t = 1,25 mm

L (m)	1,50	1,75	2,00	2,25	2,50	2,75	3,00	3,25	3,50	3,75	4,00	4,25	4,50	4,75	5,00	5,25	5,50	5,75	6,00
$q_{Rd-SLS-L/200}$	106,10	66,84	44,77	31,45	22,92	17,22	13,27	10,43	8,35	6,79	5,60	4,67	3,93	3,34	2,87	2,48	2,15	1,88	1,66
$q_{Rd-SLS-L/300}$	70,75	44,56	29,85	20,96	15,28	11,48	8,84	6,96	5,57	4,53	3,73	3,11	2,62	2,23	1,91	1,65	1,44	1,26	1,11
q_{Rd-ULS}	38,81	28,51	21,83	17,25	13,97	11,55	9,70	8,27	7,13	6,21	5,46	4,83	4,31	3,87	3,49	3,17	2,89	2,64	2,43

Ultimate loads in kN/m² for the operation and the ultimate limit states.

Lightweight steel panel design panels Symdeck 73

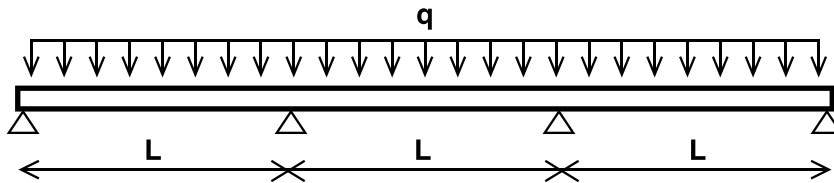

t = 0,75 mm

L (m)	1,50	1,75	2,00	2,25	2,50	2,75	3,00	3,25	3,50	3,75	4,00	4,25	4,50	4,75	5,00	5,25	5,50	5,75	6,00
$q_{Rd-SLS-L/200}$	49,60	31,23	20,92	14,70	10,71	8,05	6,20	4,88	3,90	3,17	2,62	2,18	1,84	1,56	1,34	1,16	1,01	0,88	0,77
$q_{Rd-SLS-L/300}$	33,06	20,82	13,95	9,80	7,14	5,37	4,13	3,25	2,60	2,12	1,74	1,45	1,22	1,04	0,89	0,77	0,67	0,59	0,52
q_{Rd-ULS}	23,87	17,54	13,43	10,61	8,59	7,10	5,97	5,08	4,38	3,82	3,36	2,97	2,65	2,38	2,15	1,95	1,78	1,62	1,49

Ultimate loads in kN/m² for the operation and the ultimate limit states.

t = 1,00 mm

L (m)	1,50	1,75	2,00	2,25	2,50	2,75	3,00	3,25	3,50	3,75	4,00	4,25	4,50	4,75	5,00	5,25	5,50	5,75	6,00
$q_{Rd-SLS-L/200}$	66,37	41,80	28,00	19,67	14,34	10,77	8,30	6,53	5,22	4,25	3,50	2,92	2,46	2,09	1,79	1,55	1,35	1,18	1,04
$q_{Rd-SLS-L/300}$	44,25	27,86	18,67	13,11	9,56	7,18	5,53	4,35	3,48	2,83	2,33	1,95	1,64	1,39	1,19	1,03	0,90	0,79	0,69
q_{Rd-ULS}	35,46	26,05	19,95	15,76	12,76	10,55	8,86	7,55	6,51	5,67	4,99	4,42	3,94	3,54	3,19	2,89	2,64	2,41	2,22

Ultimate loads in kN/m² for the operation and the ultimate limit states.

t = 1,25 mm

L (m)	1,50	1,75	2,00	2,25	2,50	2,75	3,00	3,25	3,50	3,75	4,00	4,25	4,50	4,75	5,00	5,25	5,50	5,75	6,00
$q_{Rd-SLS-L/200}$	83,14	52,36	35,08	24,64	17,96	13,49	10,39	8,17	6,54	5,32	4,38	3,66	3,08	2,62	2,24	1,94	1,69	1,48	1,30
$q_{Rd-SLS-L/300}$	55,43	34,91	23,38	16,42	11,97	9,00	6,93	5,45	4,36	3,55	2,92	2,44	2,05	1,75	1,50	1,29	1,12	0,98	0,87
q_{Rd-ULS}	48,51	35,64	27,29	21,56	17,46	14,43	12,13	10,33	8,91	7,76	6,82	6,04	5,39	4,84	4,37	3,96	3,61	3,30	3,03

Ultimate loads in kN/m² for the operation and the ultimate limit states.

Composite floor decks construction details

SIDE END DETAIL

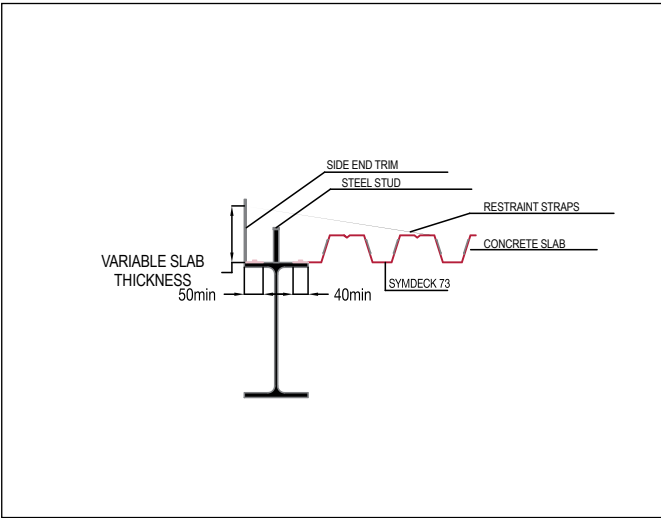

CANTILEVER SIDE END DETAIL

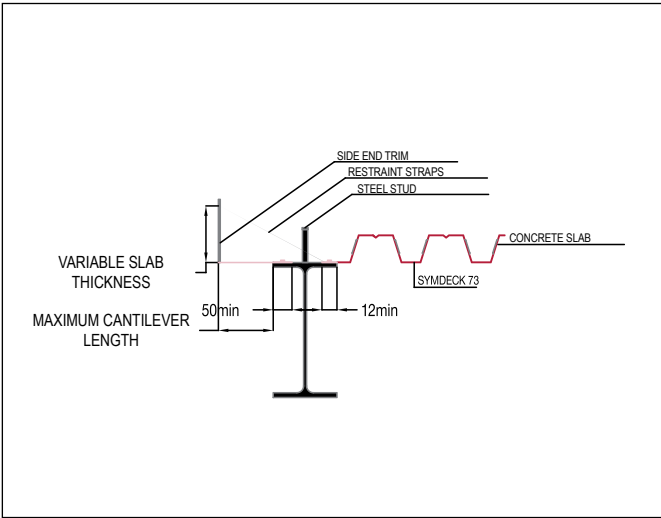

END DETAIL

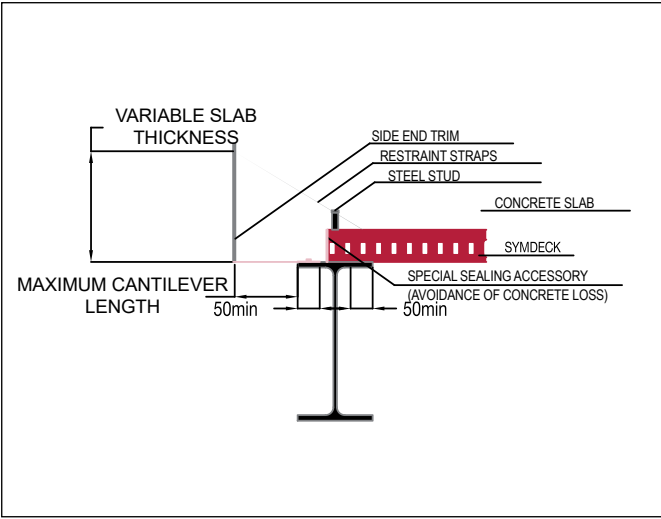

CANTILEVER END DETAIL

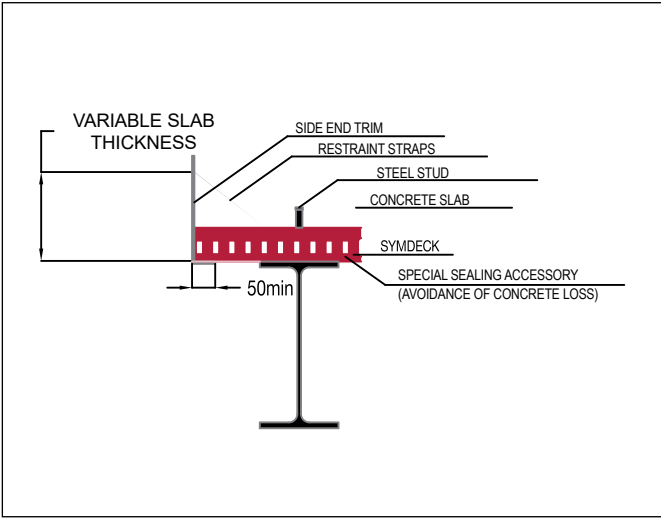

DETAIL OF COMPOSITE FLOOR WITH DIRECTION CHANGE

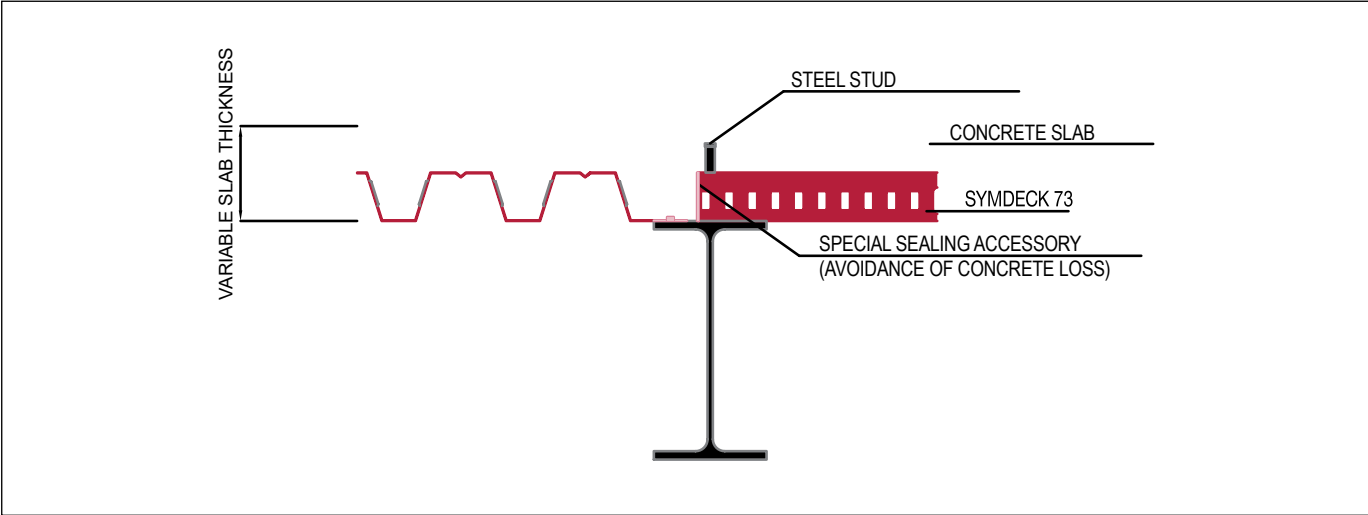

Composite floor decks construction details

STEEL OR CONCRETE BEAM AND SUPPORT

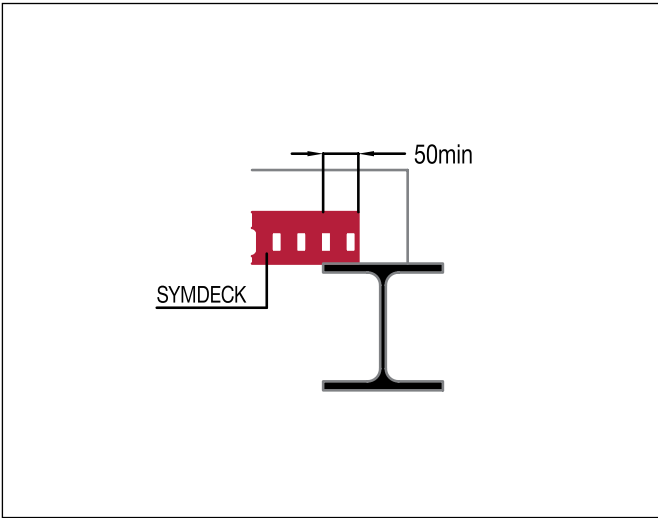

DOUBLE SUPPORT ON STEEL OR CONCRETE BEAM

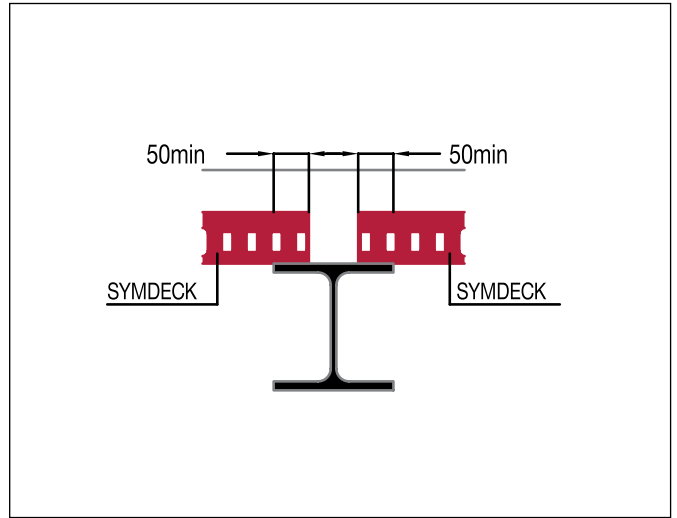

CONTINUOUS SUPPORT ON STEEL OR CONCRETE BEAM

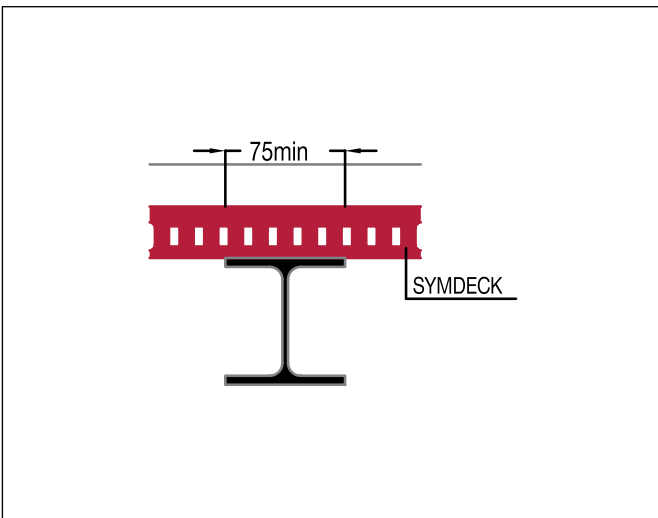

END DETAIL SUPPORT ON WALL

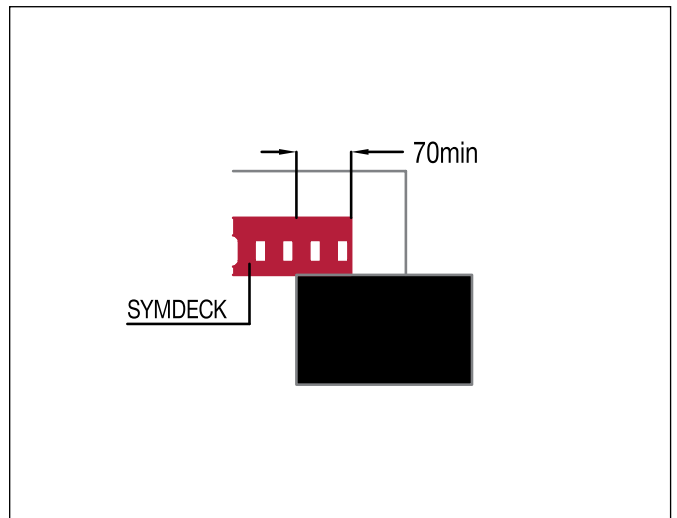

DOUBLE SUPPORT ON WALL

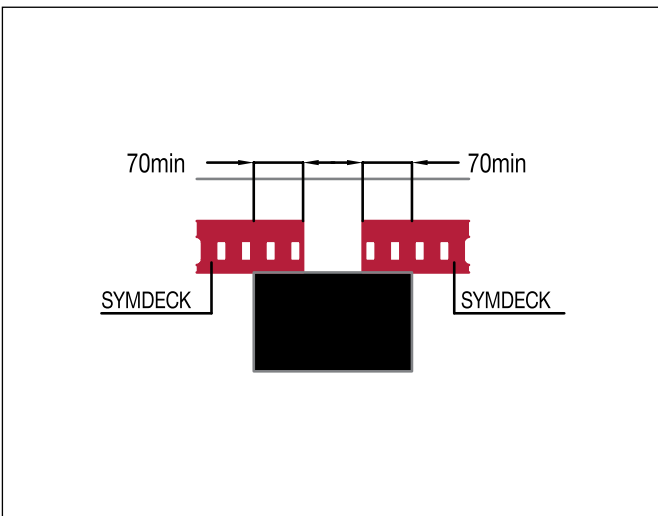

CONTINUOUS SUPPORT WALL

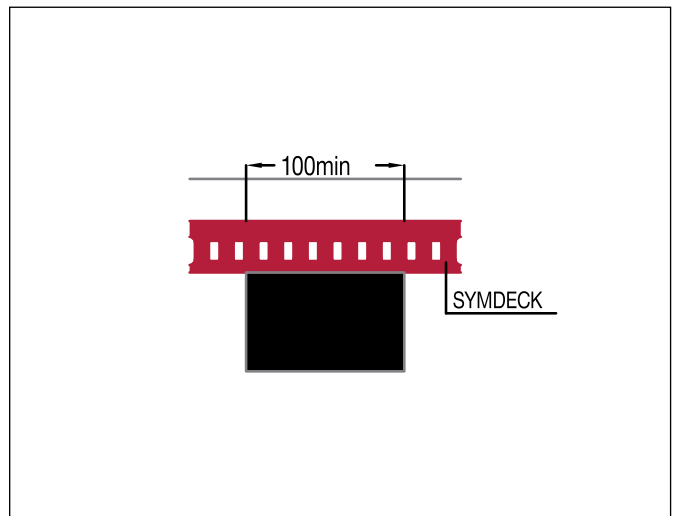

The information, descriptions, procedures, specifications, and dimensions contained in this catalogue are true and valid until the date of issue. ELASTRON S.A. STEEL SERVICE CENTERS reserves the right to make changes to the design, and the materials of its products for their improvement or removal, without prior notice. Although ELASTRON S.A. STEEL SERVICE CENTERS has made every effort to ensure that the information, technical instructions and data presented in this catalogue are accurate, nevertheless it remains for the user (reader) the obligation to verify whether the above are suitable to cover any of its needs. The company is not liable and is not responsible for any technical or typographical errors that cannot be predicted or have occurred unintentionally or due to force majeure. Especially for the elaboration of particular mechanical engineering studies, we ask you to contact the technical department of our company, in order to receive an updated copy of our catalogue, and to provide you with information and clarifications regarding the data listed in it.

October 2020

ELASTRON S.A.

Agios Ioannis Street, Ag. Ioannis,
193 00, Aspropyrgos , Athens, Greece

Tel. +30 210 5515 000

Fax +30 210 5515 015

elastron@elastron.gr

www.elastron.gr